

SECTIUNE TRANSVERSALA
CROSS SECTION

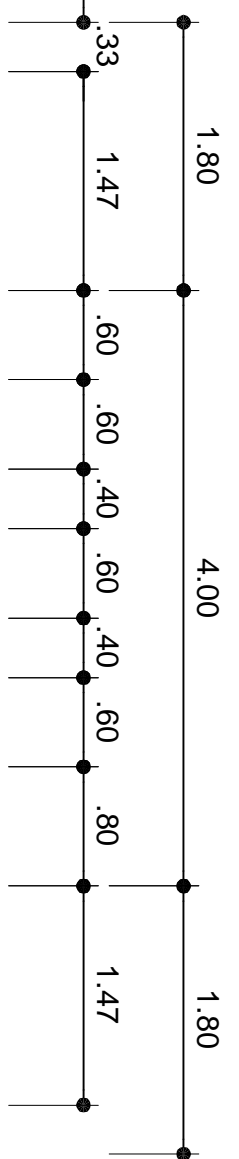

FATADA LA LINII
TRACKS FACADE
- Sc. 1:50 -

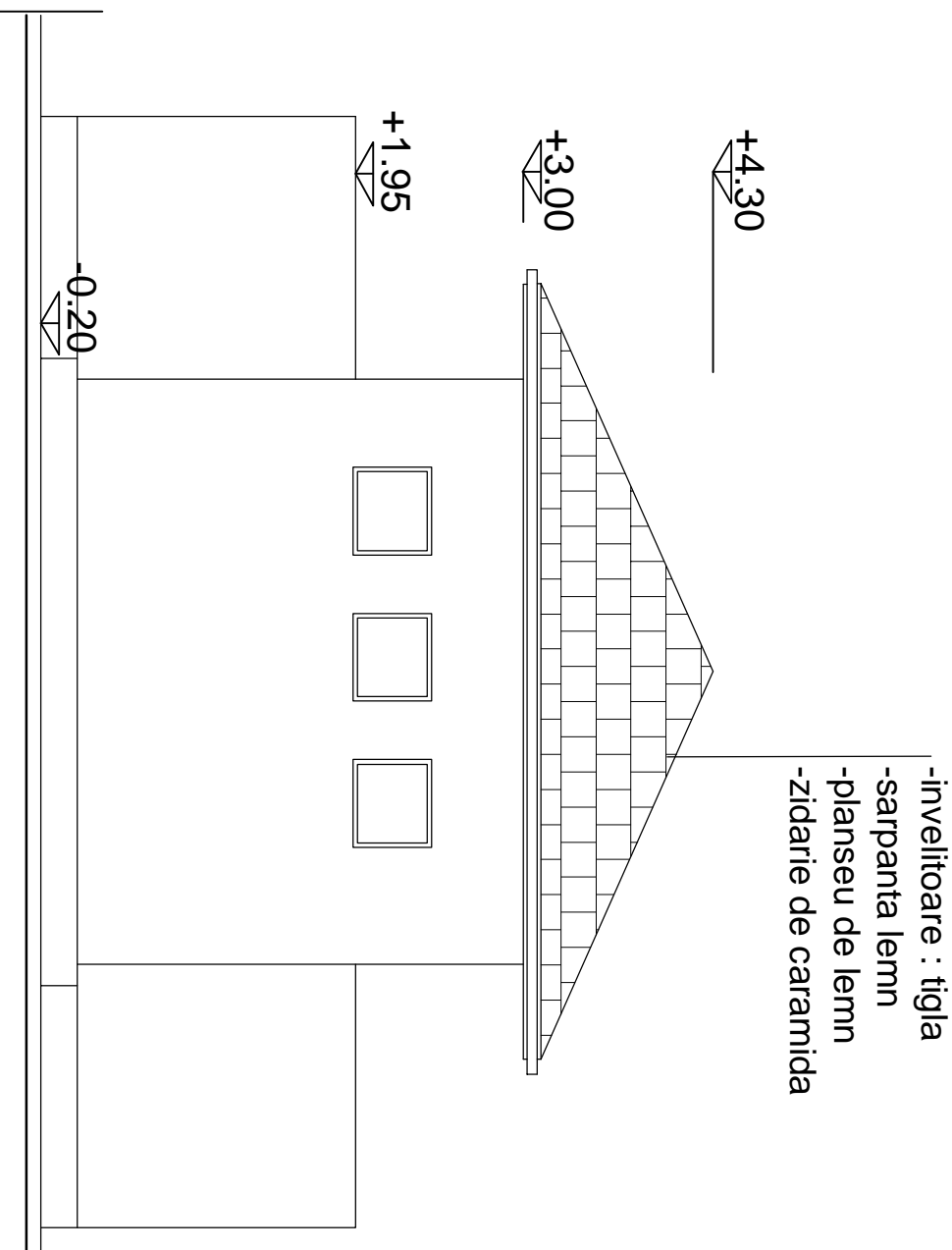

FATADA POSTERIOARA
POSTERIOR FACADE
- Sc. 1:50 -

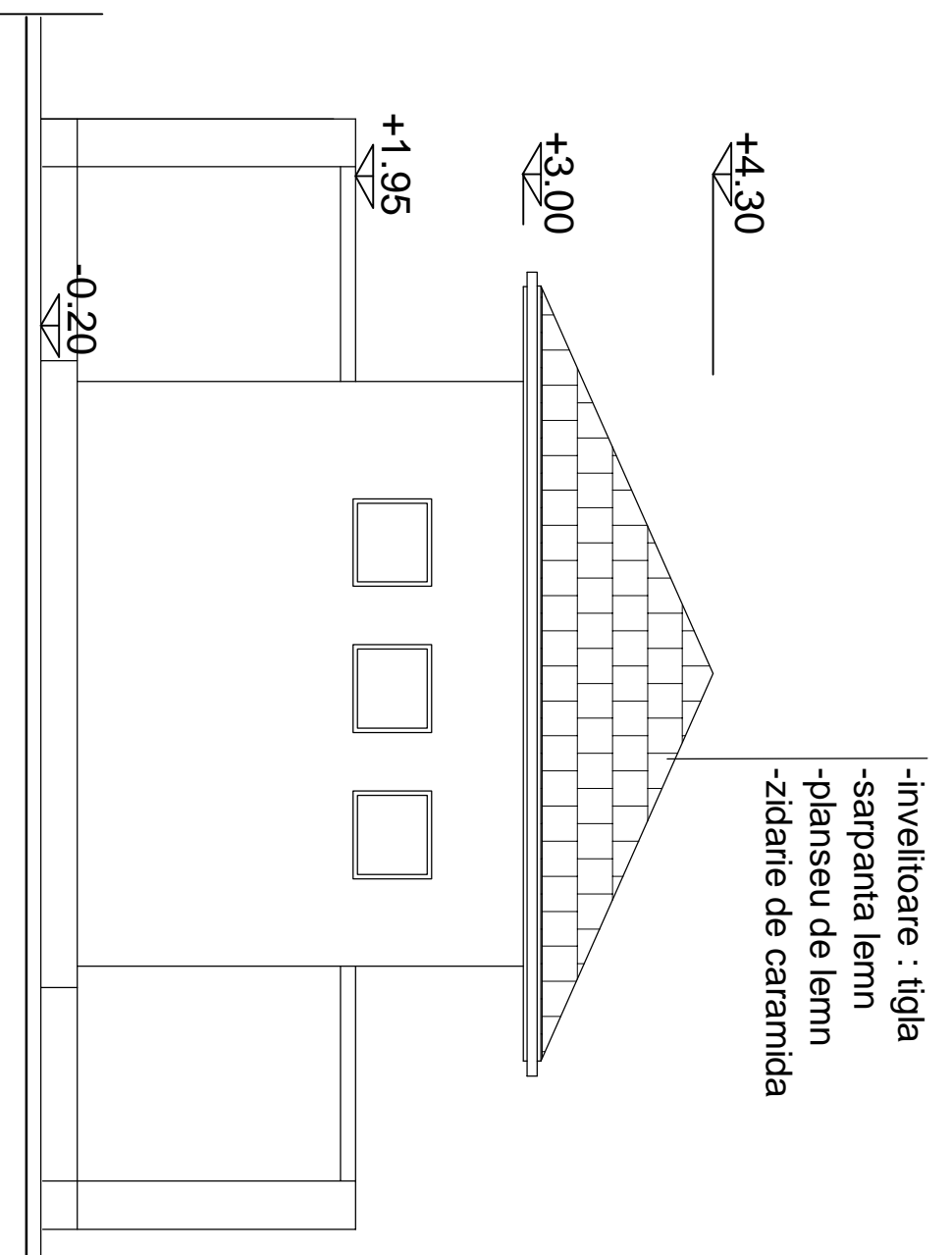

FATADA LATERAL DREAPTA-RIGHT SIDE FACADE
- Sc. 1:50 -

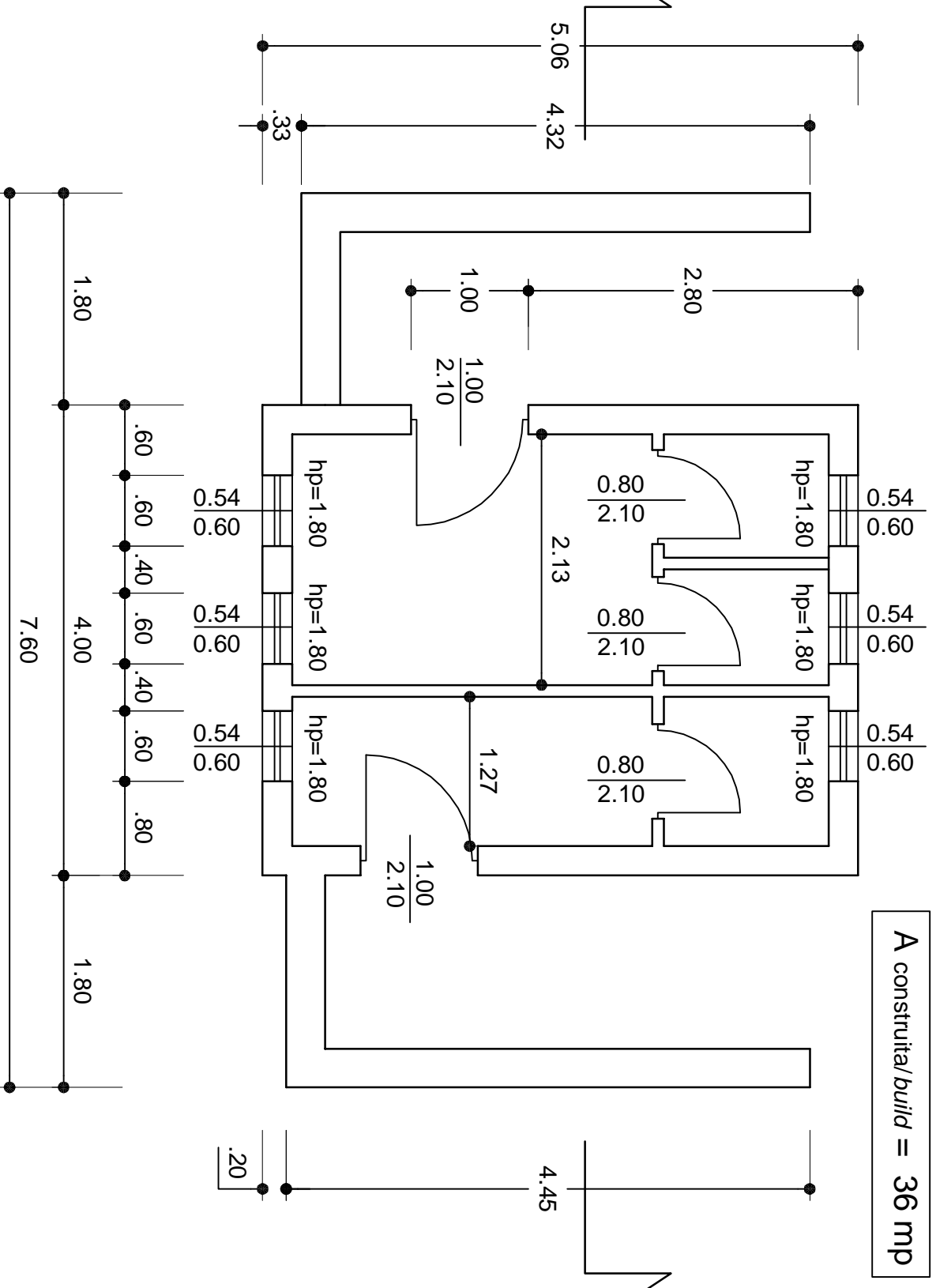
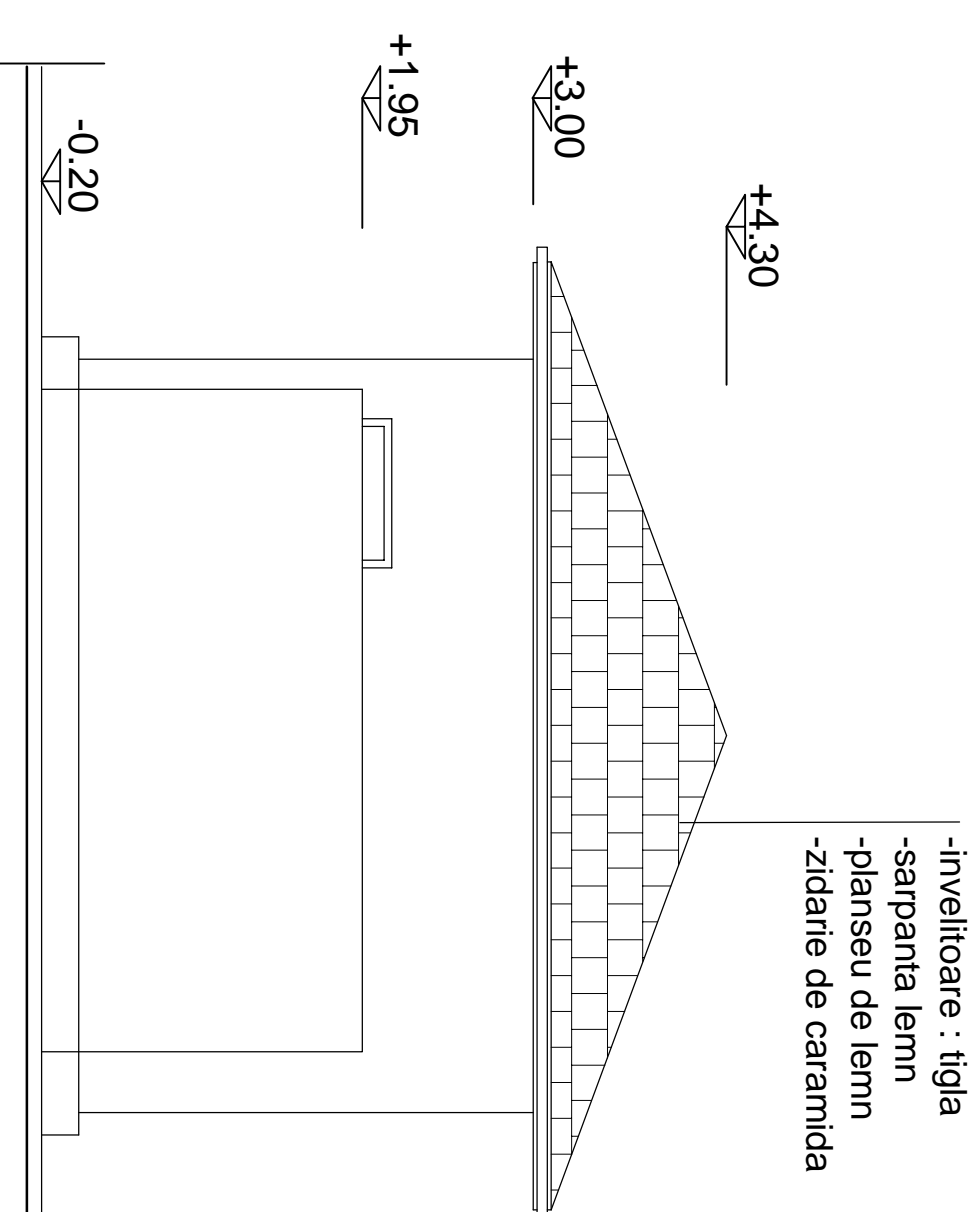

GRUP SANITAR - PLAN PARTER
SANITARY GROUP - GROUND FLOOR

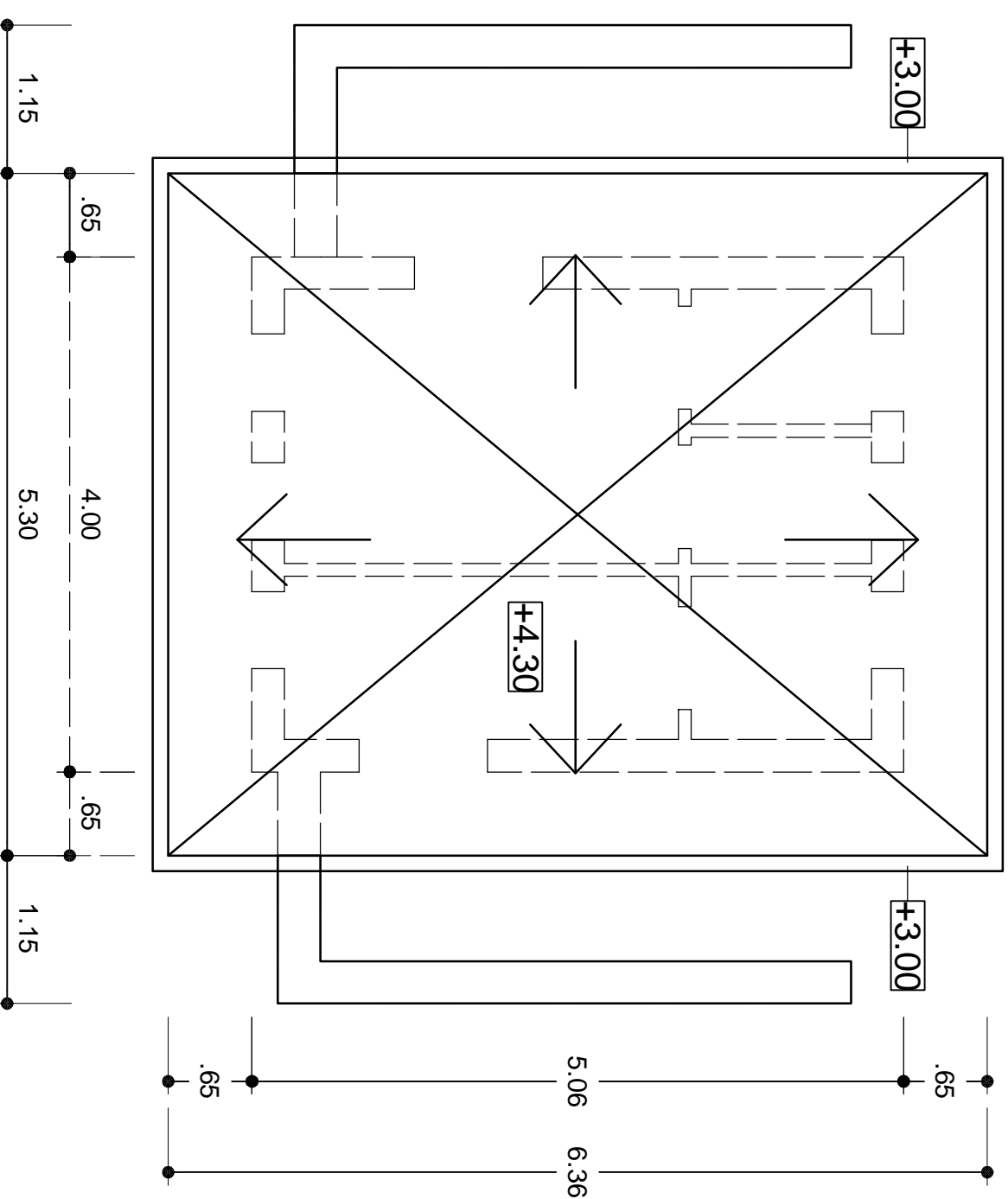

PLAN ACOPERIS - ROOF PLAN
SC.1:50

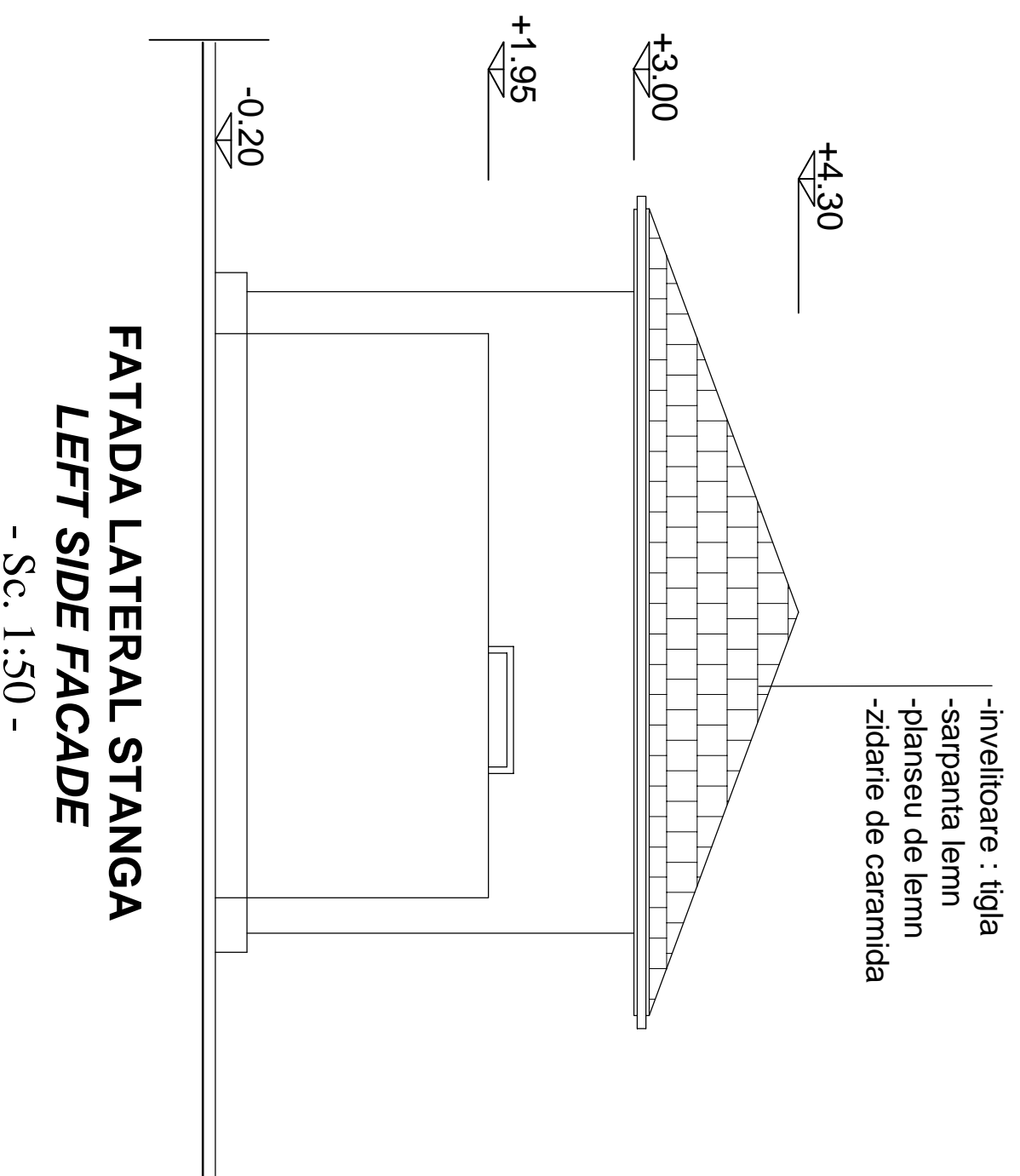

FATADA LATERAL STANGA
LEFT SIDE FACADE
- Sc. 1:50 -

D					
C					
B					
A					
Index	Data	Modificari/Revision	Proiectant	Approbat CFR	Approbat CFR
	Data		Designer	Approved/Consultant	Approved/CFR

GUVERNUL ROMANIEI
ROMANIAN GOVERNMENT

PROIECT FINAN TAT DE UNIUNEA EUROPEANA A
EUROPEAN UNION FINANCED PROJECT

CLIENT / CLIENT



C.N.C.F. "C.F.R." - S.A.

CONSULTANT / CONSULTANT

guburo resione BELLO STATO
Joint Venture leader

SCOTT WILSON

OBERMEYER
PLANEN + BERATUN GmbH

TECNIC
Consulting Engineers

Approbat	Set proiect	R. Luzzi	12. 2011	
Approbat	Coordonator Sectiune 1	C. Gambelli	12. 2011	
Verificat	Verificator	Giuseppe Fioravanti	12. 2011	

SUBCONTRACTANT / SUBCONTRACTOR

Approbat	Responsabilul Subcontractant	A. Stancu - Dinulescu	12. 2011	
Intocmit	Subcontractant Responsible	Andreea Stancu	12. 2011	

Denumire desen / Drawing Title :

STATIJA RACOS DEMOLARE GRUP SANITAR PLAN FATADE SECTIUNE
RAILWAY STATION RACOS DISMANTLING OF SANITARY GROUP PLAN,
FACADES, SECTION

Codificare / Codification System

E	A	5	1	0	1	E	1	1	A	B	C	C	0	2	0	0	0	0	4	0
---	---	---	---	---	---	---	---	---	---	---	---	---	---	---	---	---	---	---	---	---