

PLAN ARMARE PLACA PESTIE PARTIER SC. 150 REINFORCING PLAN - SLAB OVER THE GROUND FLOOR

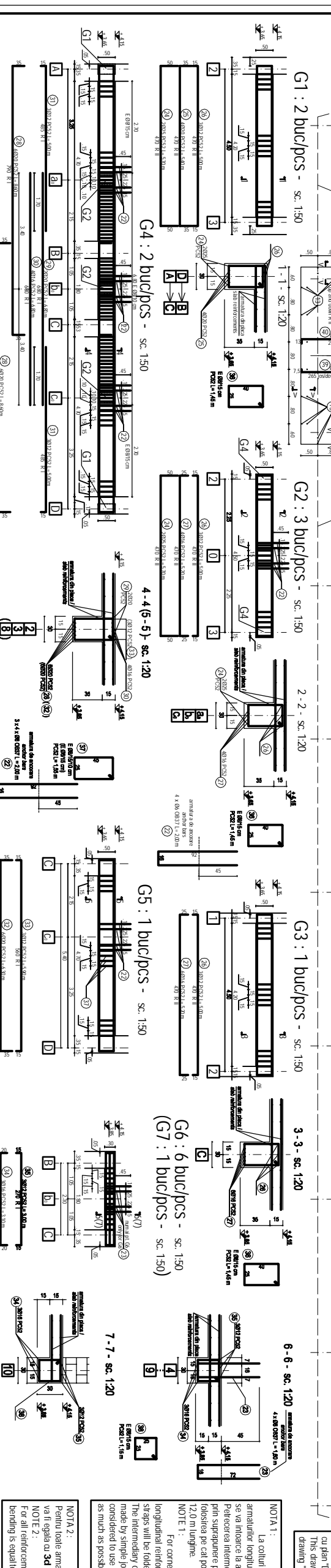

DET. "a" : 24 buc/pcs - sc. 120 DET. "b" : 3 buc/pcs - sc. 120

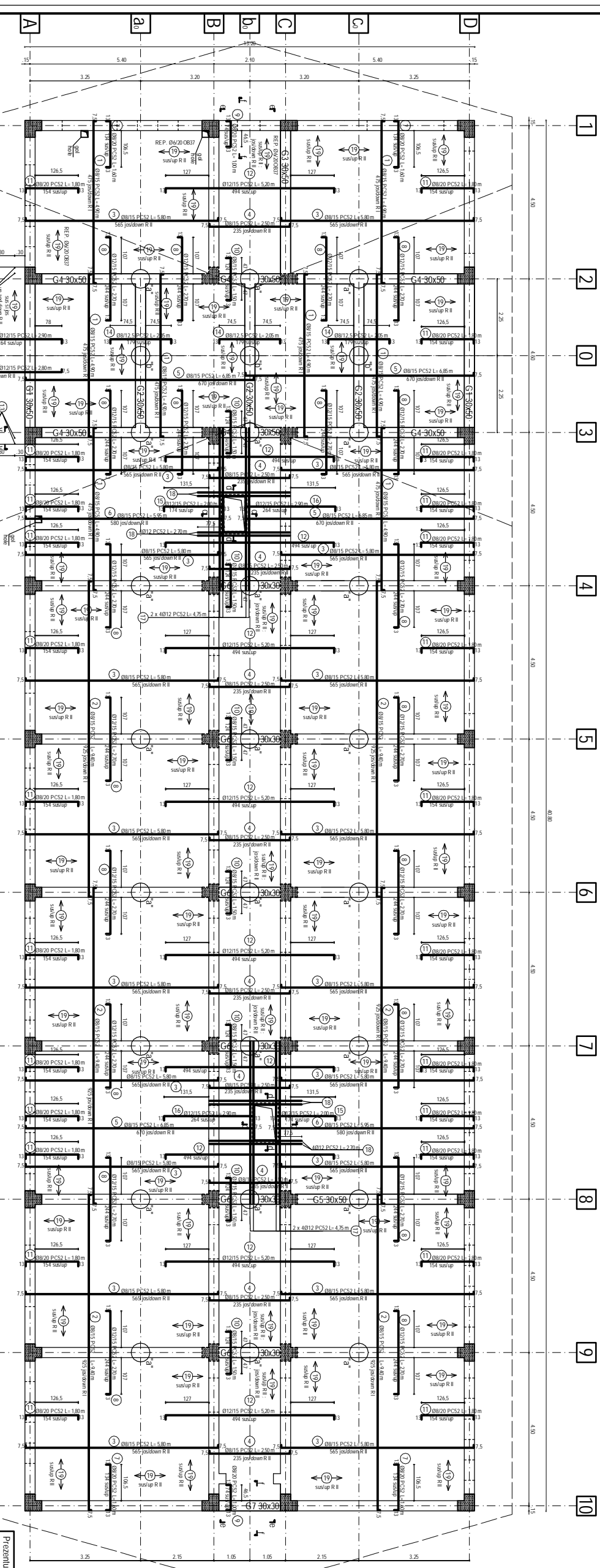
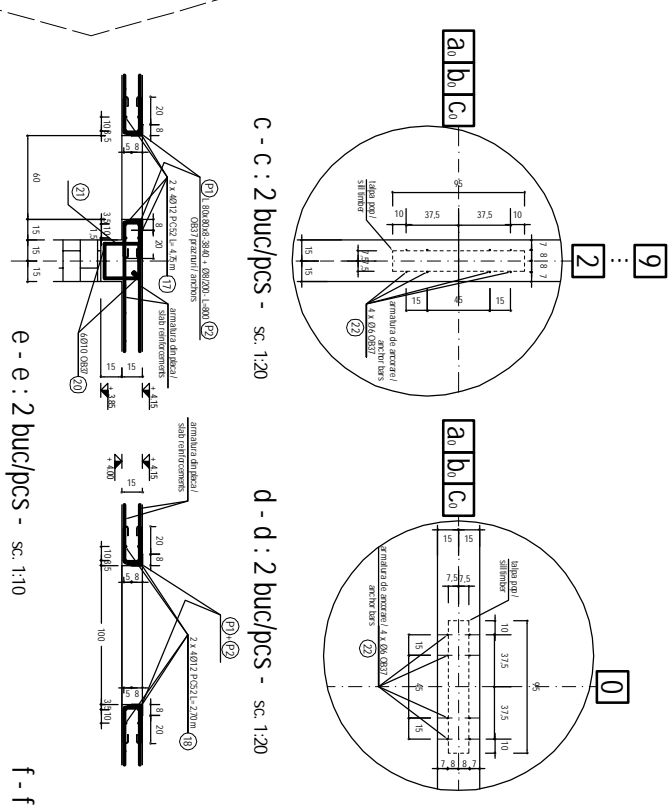

CANTONAMINTUL DE REINFORCARE AL PLACII DE PESTIE A SC. 150										
ID	PROIECTANT	VERIFICATOR	DATA	STATIUNTA	PROIECTANT	VERIFICATOR	DATA	STATIUNTA	PROIECTANT	VERIFICATOR
G1	2 buc/pcs - sc. 150									
G2	3 buc/pcs - sc. 150									
G3	1 buc/pcs - sc. 150									
G4	2 buc/pcs - sc. 150									
G5	1 buc/pcs - sc. 150									
G6	6 buc/pcs - sc. 150									
G7	1 buc/pcs - sc. 150									
G8	2 buc/pcs - sc. 120									



PROIECTANTUL SI EXECUTANTUL DEBUTANTII
REINFORCAREI DEBUTANTII
DEBUTANTII DEBUTANTII

NOTA 1: La coltar si in zona de invecinarea cu coltarul se va realiza o armare suplimentara cu o dimensiune a barelor de 100 cm. Sa se realizeze o armare suplimentara cu o dimensiune a barelor de 100 cm. Sa se realizeze o armare suplimentara cu o dimensiune a barelor de 100 cm.

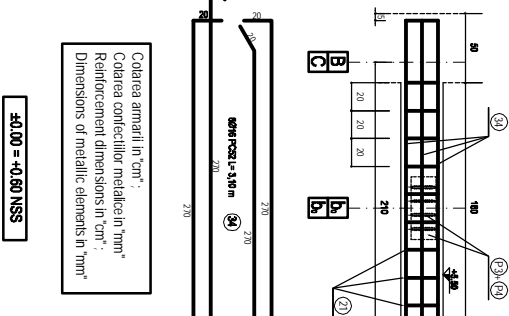
REINFORCARE DE BAZA
CANTONAMINTUL DE REINFORCARE AL PLACII DE PESTIE A SC. 150



ID	PROIECTANT	VERIFICATOR	DATA	STATIUNTA	PROIECTANT	VERIFICATOR	DATA	STATIUNTA	PROIECTANT	VERIFICATOR
G1	2 buc/pcs - sc. 150									
G2	3 buc/pcs - sc. 150									
G3	1 buc/pcs - sc. 150									
G4	2 buc/pcs - sc. 150									
G5	1 buc/pcs - sc. 150									
G6	6 buc/pcs - sc. 150									
G7	1 buc/pcs - sc. 150									
G8	2 buc/pcs - sc. 120									

 ENERCON CONSULTING CONSULTANT / CONSULTANT	 OBERNEUER TECNIC CONSULTANT / CONSULTANT	 CACF-C&A CONSULTANT / CONSULTANT
<p>PROIECTANTUL SI EXECUTANTUL DEBUTANTII REINFORCAREI DEBUTANTII DEBUTANTII DEBUTANTII</p>		
<p>REINFORCARE DE BAZA CANTONAMINTUL DE REINFORCARE AL PLACII DE PESTIE A SC. 150</p>		