

ROOF DETAIL/DETALIU DE ACOPERIS

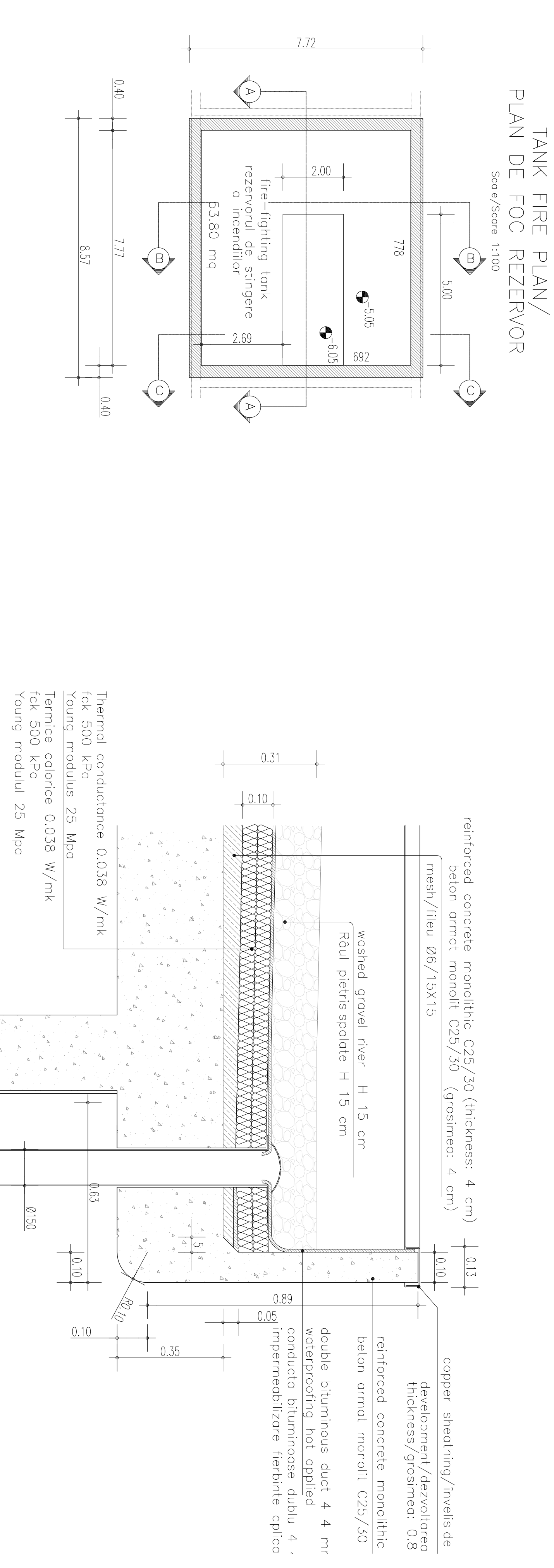

ROOF PLAN/PLAN DE ACOPERIS

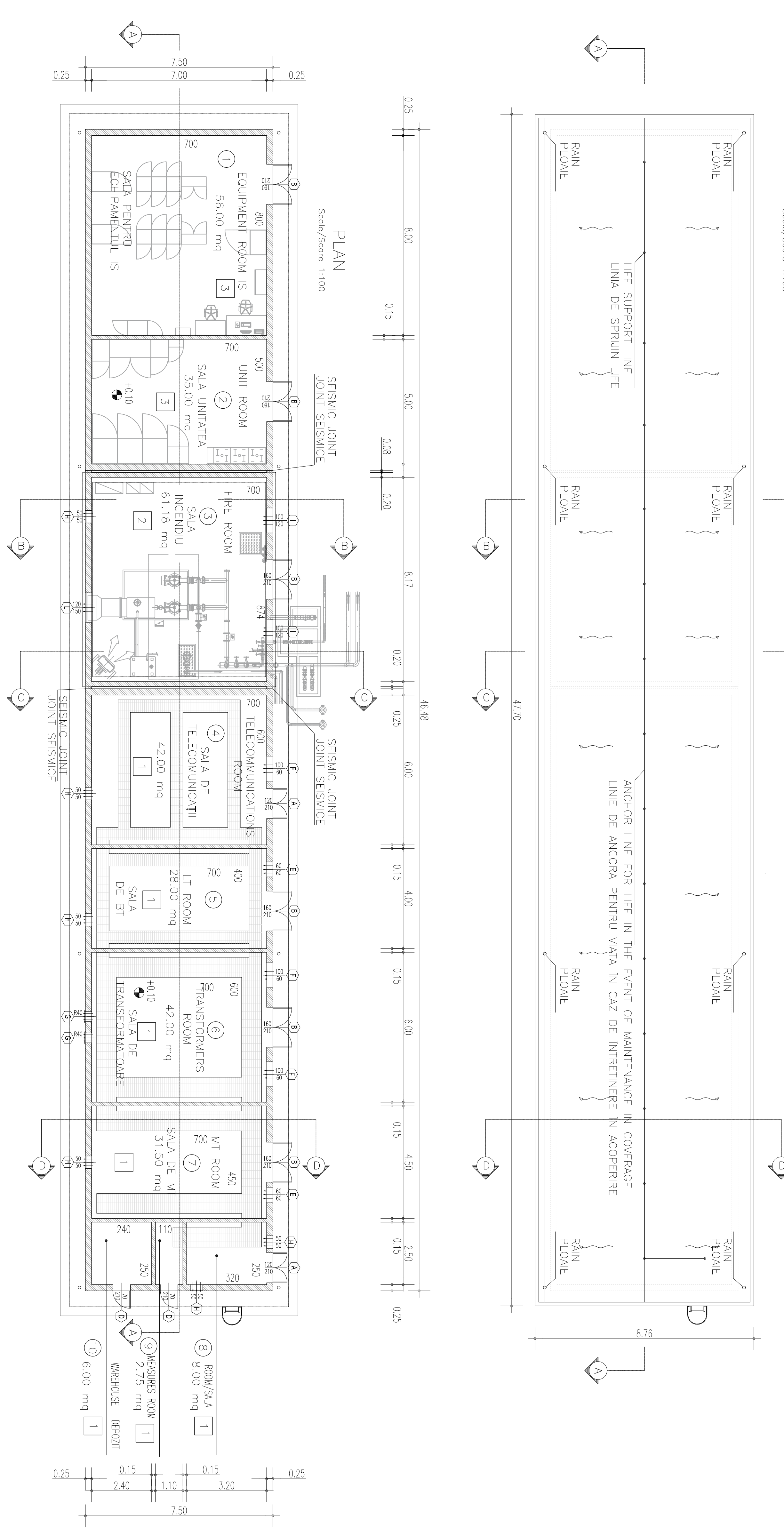

NORTH ELEVATION/NORD ELEVATIE

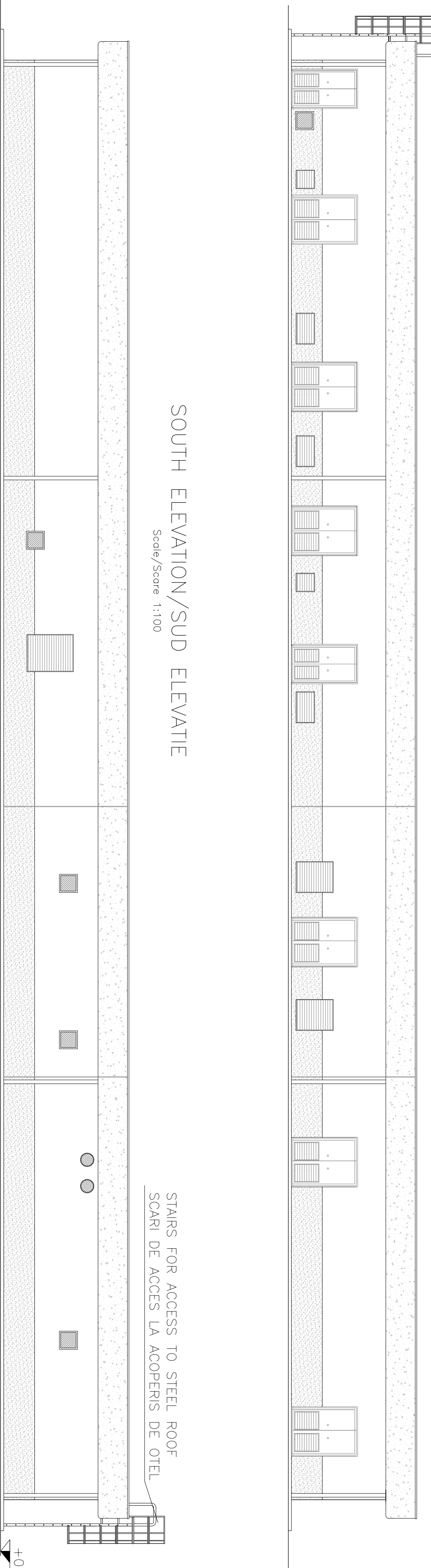

SOUTH ELEVATION/SUD ELEVATIE

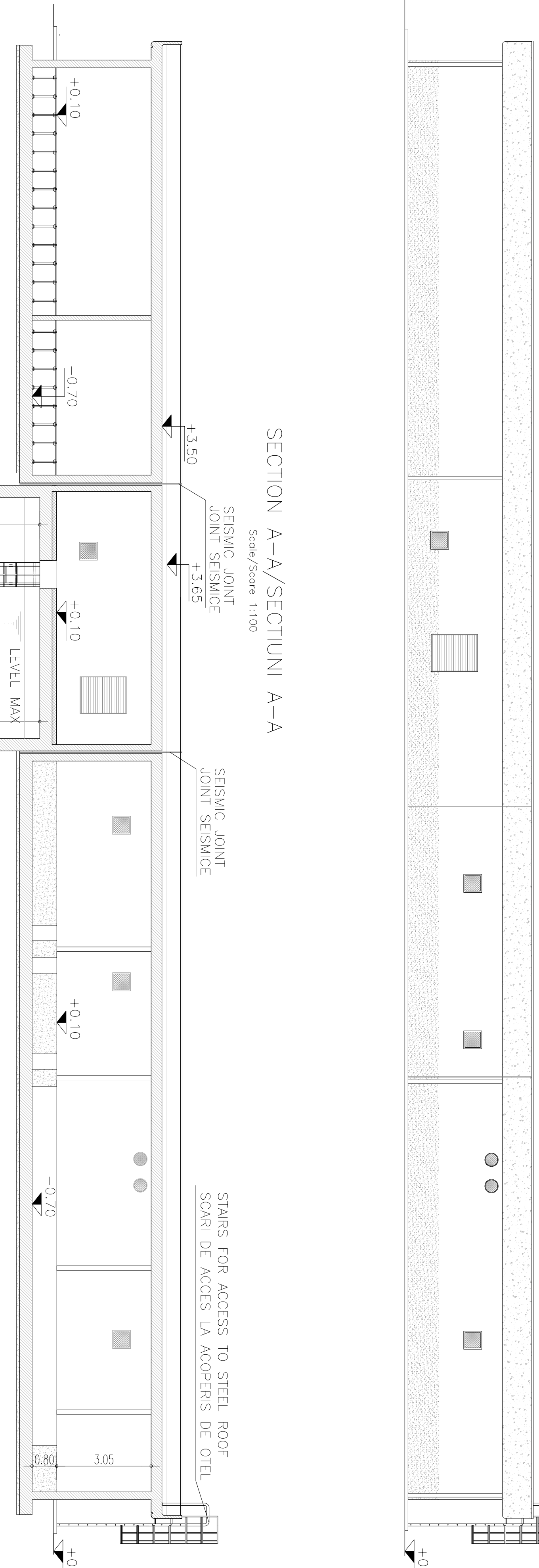

TANK FIRE PLAN/ PLAN DE FOC REZERVOR

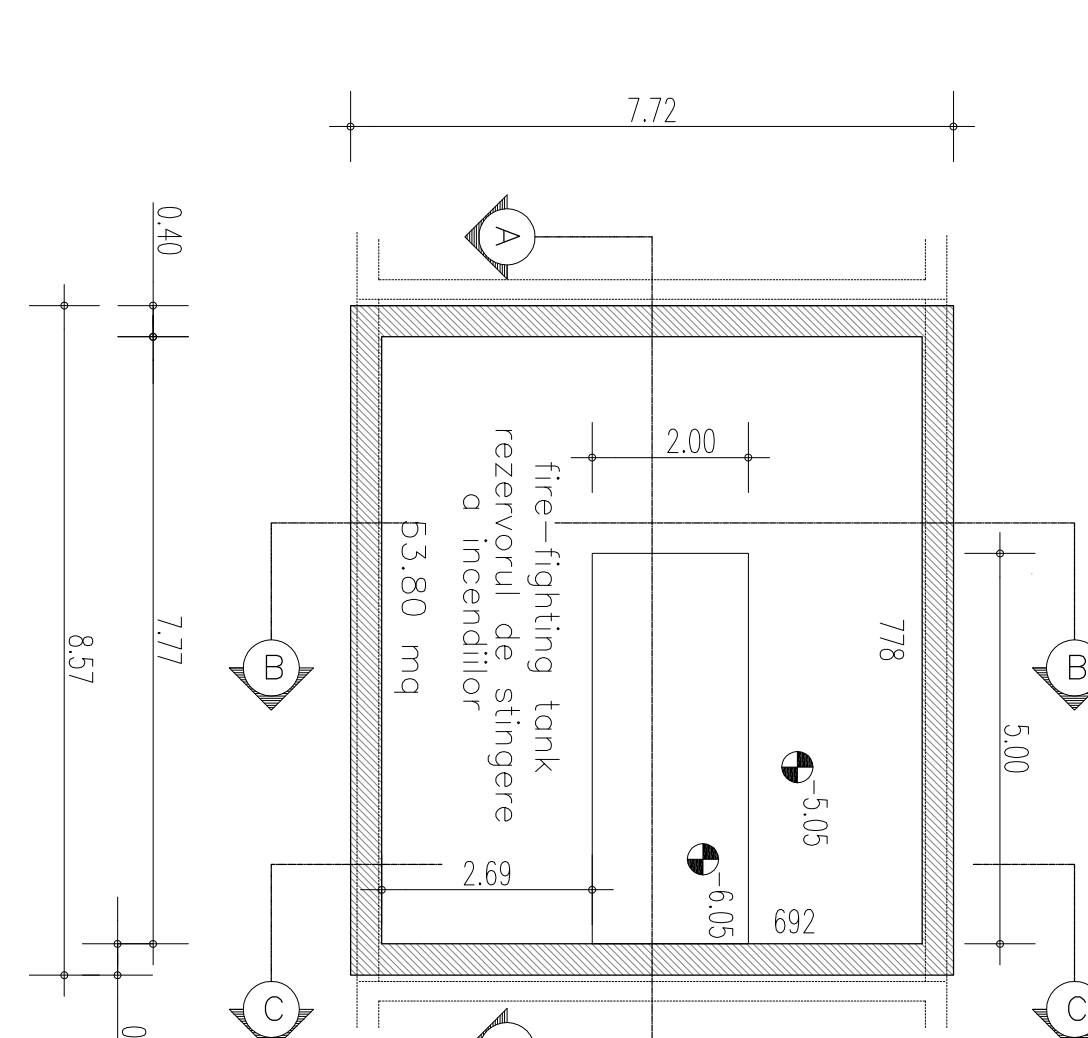

TANK BAIL PLAN/ REZERVORUL CAUTIUNE PLAN

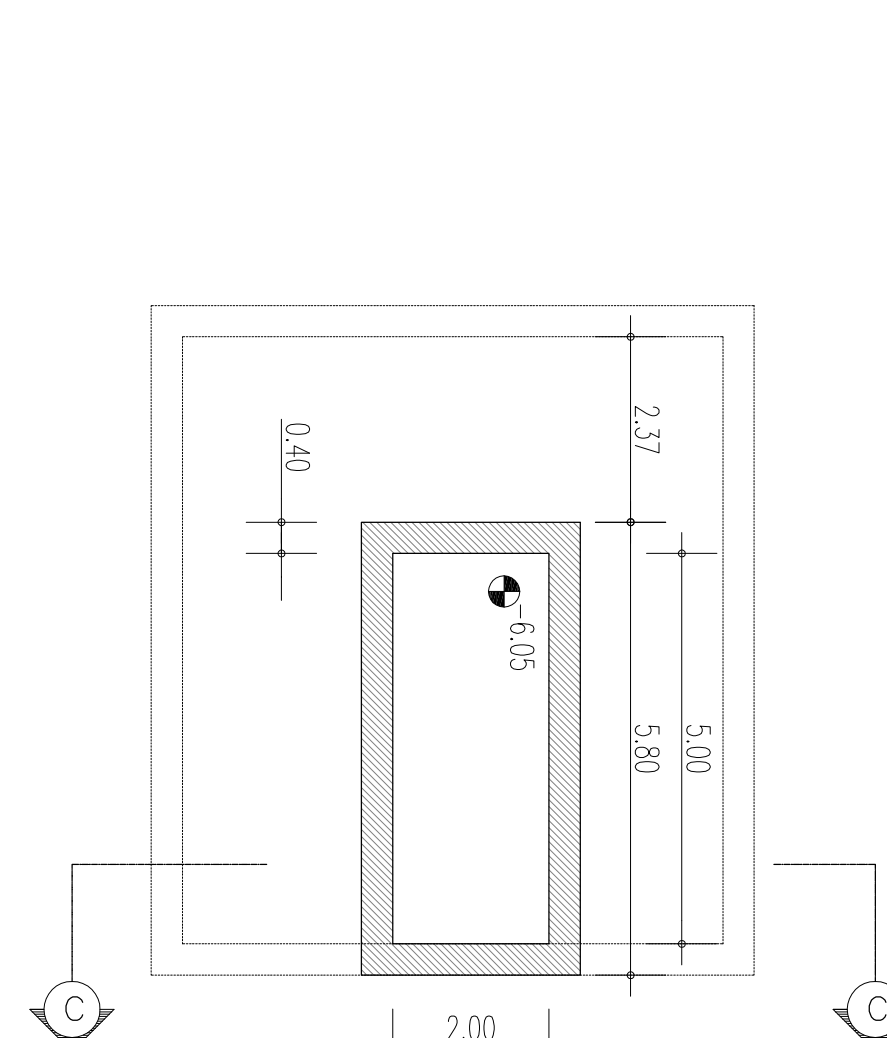

WEST ELEVATION/EST ELEVATIE

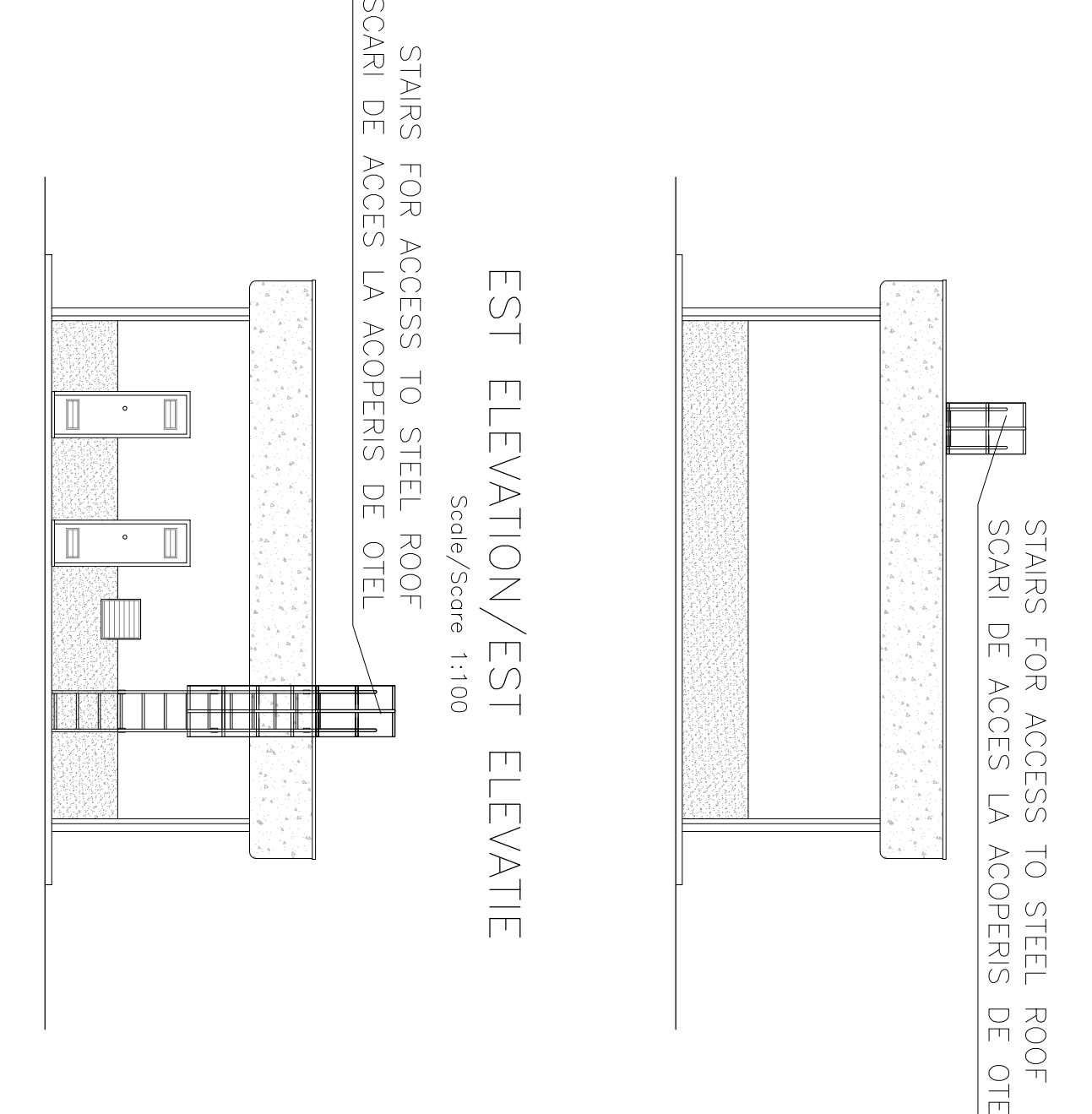

SECTION D-D/SECTIUNI D-D

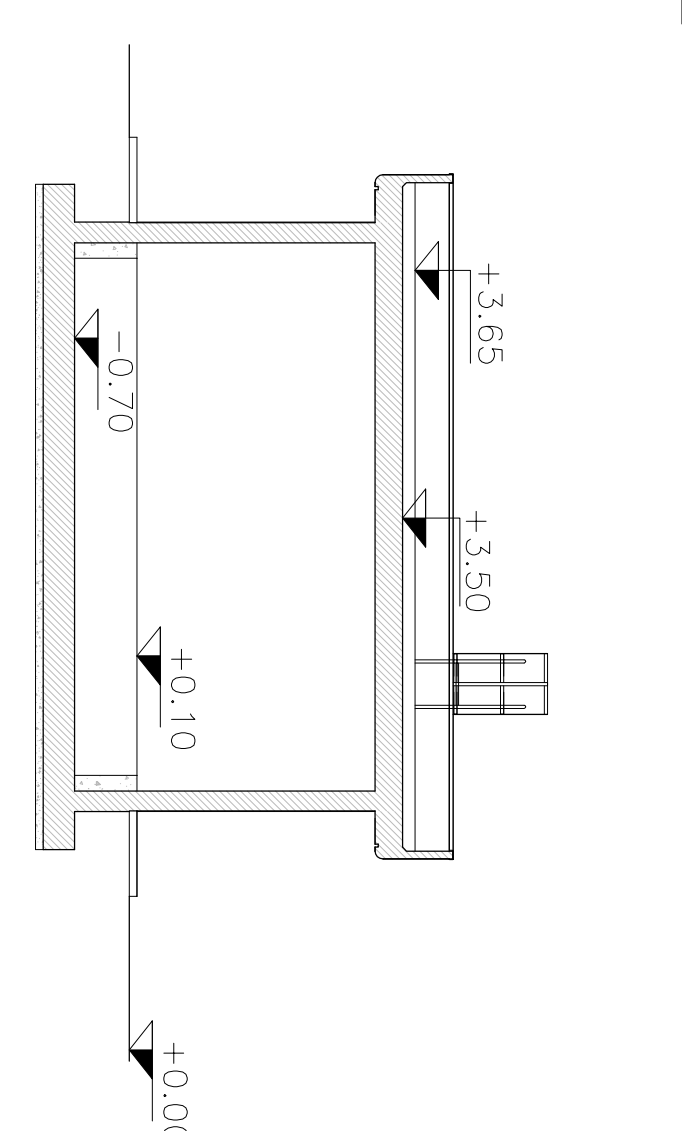

SECTION C-C/SECTIUNI C-C

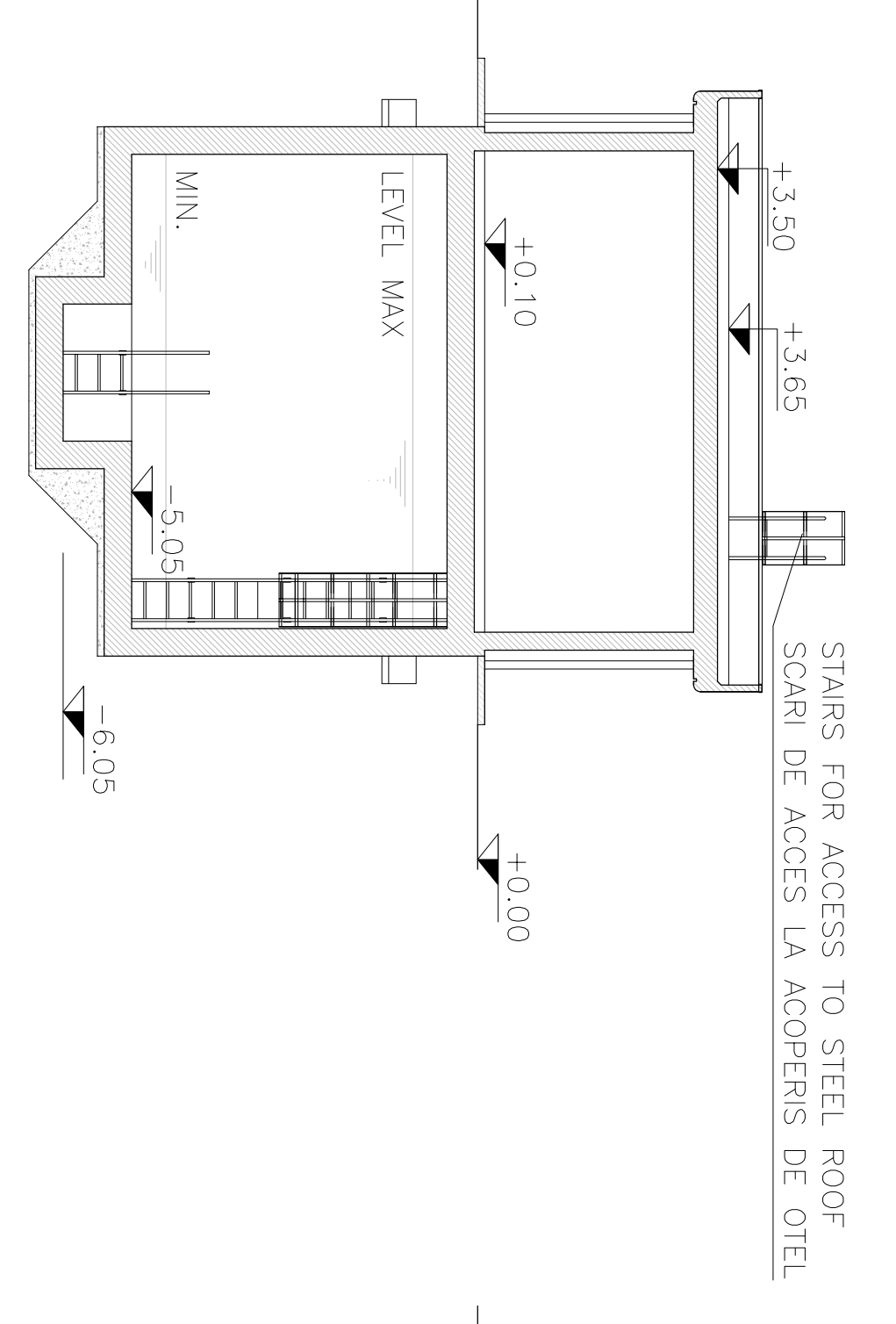

SECTION B-B/SECTIUNI B-B

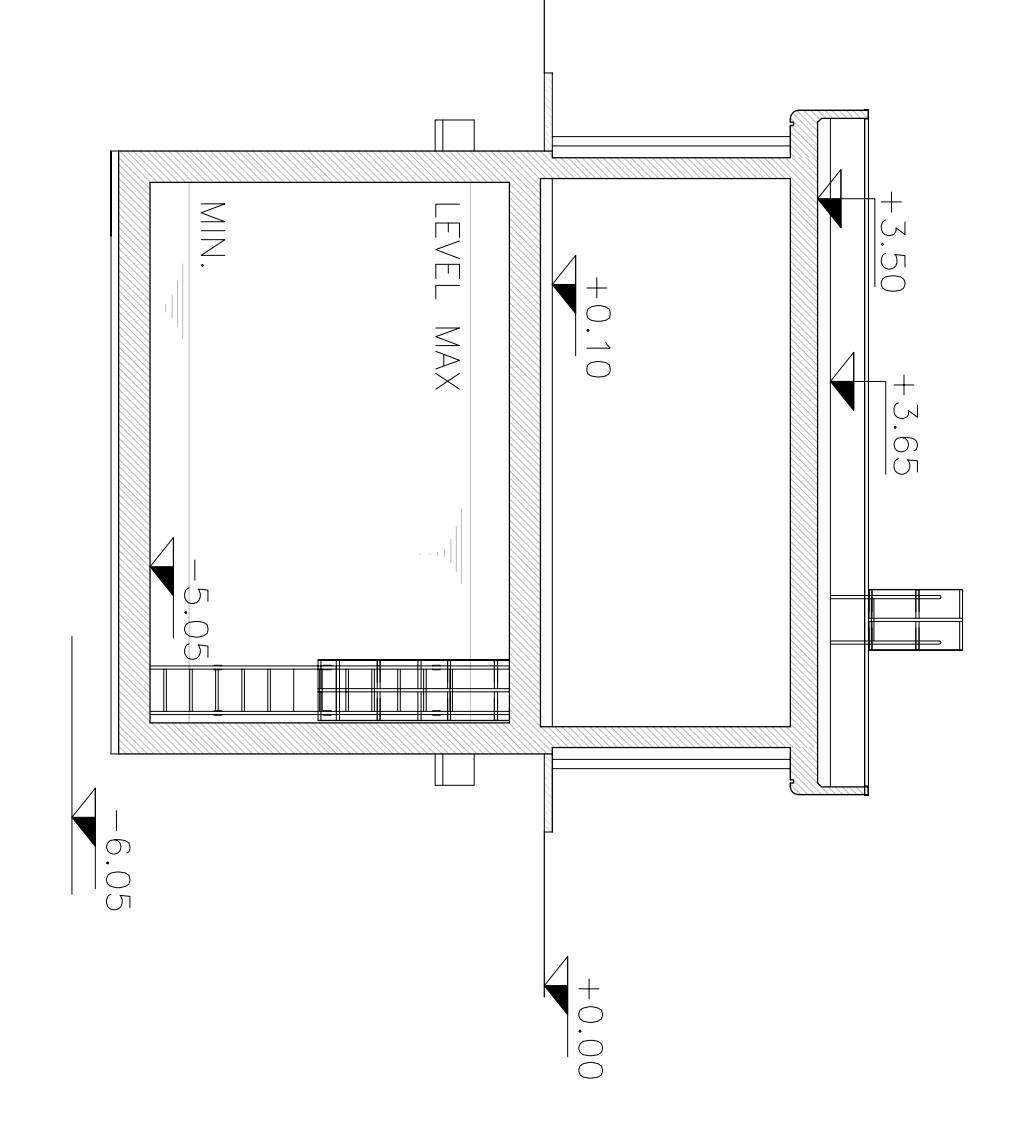

MATERIAL TABLE

- S&B CONCRETE
 - Type C2
 - Water/cement ratio 0.016
 - Maximum structural Class S3/S4
 - Exposure class related to environmental conditions: XE2
 - Class of chloride content: C 0.20
 - ϕ max aggregate = 32 mm
- REINFORCING STEEL
 - BRC/C controlled by establishment
 - Reinforce
 - Type 1-12-HP
 - ϕ max 12-HP 120 / 1/4
 - Control 95% 120 / 1/4
- LEAN CONCRETE

| | | | | | |
|-------|------|--------------------------|------------|--------------------|--------------------|
| Index | DATE | Modificari/Modifications | Proiectant | Approved/Comandant | Approved/Comandant |
| A | | | | | |
| B | | | | | |
| C | | | | | |
| D | | | | | |

CLIENT / CLIENT

GUVERNUL ROMANIEI
ROMANIAN GOVERNMENT

PROIECT FINANȚAT DE UNIUNEA EUROPEANĂ
EUROPEAN UNION FINANCED PROJECT

CONSULTANT / CONSULTANT

IBIUSOAR
SCOTT WILSON
OBENMEYER
FARNER - BERENSON GARDNER
TECNIC
Consulting Engineers

SUBCONSULTANT / SUBCONSULTANT

APROBAT/Approved: R. LUIZEA
APROBAT/Approved: C. GAMBELLI
C. GAMBELLI

PROIECT/PROJECT: HOMOROD TUNNEL

DATE: 2024/03/07/25/2025

PRINȚIPAL/PRINCIPAL: F. N. I. / F. N. I.

CONDITII/CONDITION SYSTEM: Sursa Scaun, Variet. Varietous, LOT

EA 5 1 0 1 C 1 2 TS GA 0 3 0 0 0 0 1 0