

STEEL RIBS TYPE 2 IPE 180 NERVURI DIN OTEL TIP 2 IPE 180

Scale/Scala 1:20

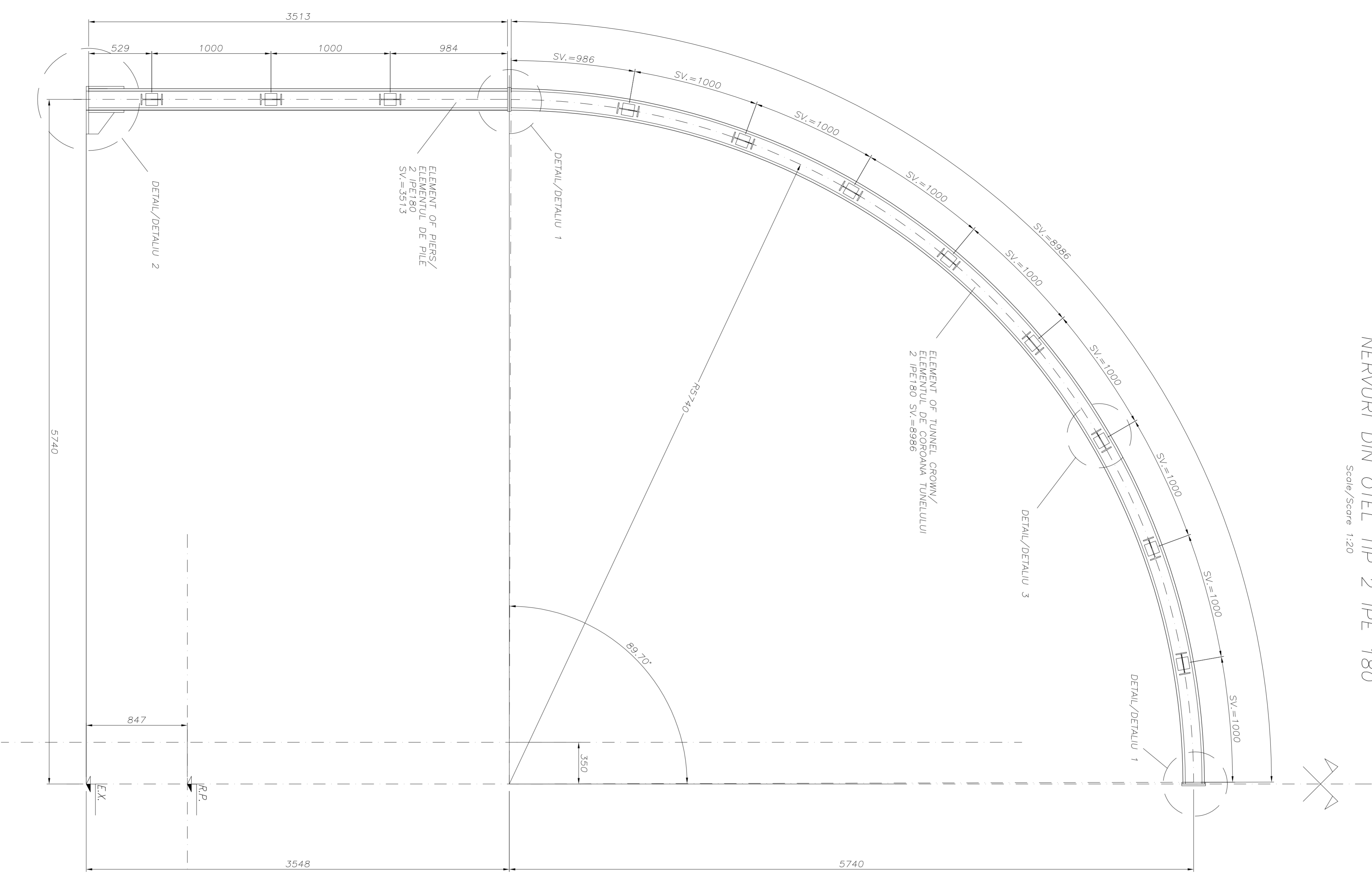

DETAIL "1" DETALIU "1"

Scale/Scala 1:5

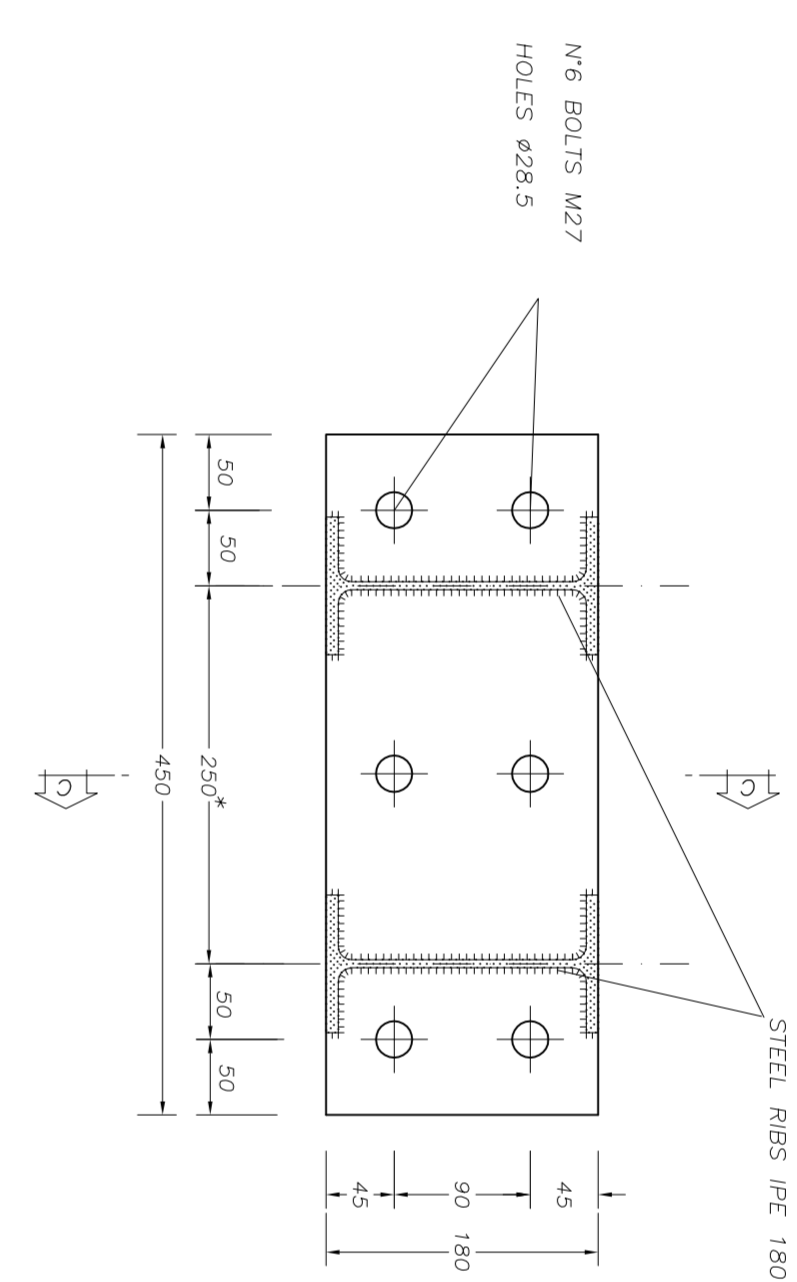

ON PIERS
PE PILE

SECTION A-A SECTIUNI A-A

Scale/Scala 1:5

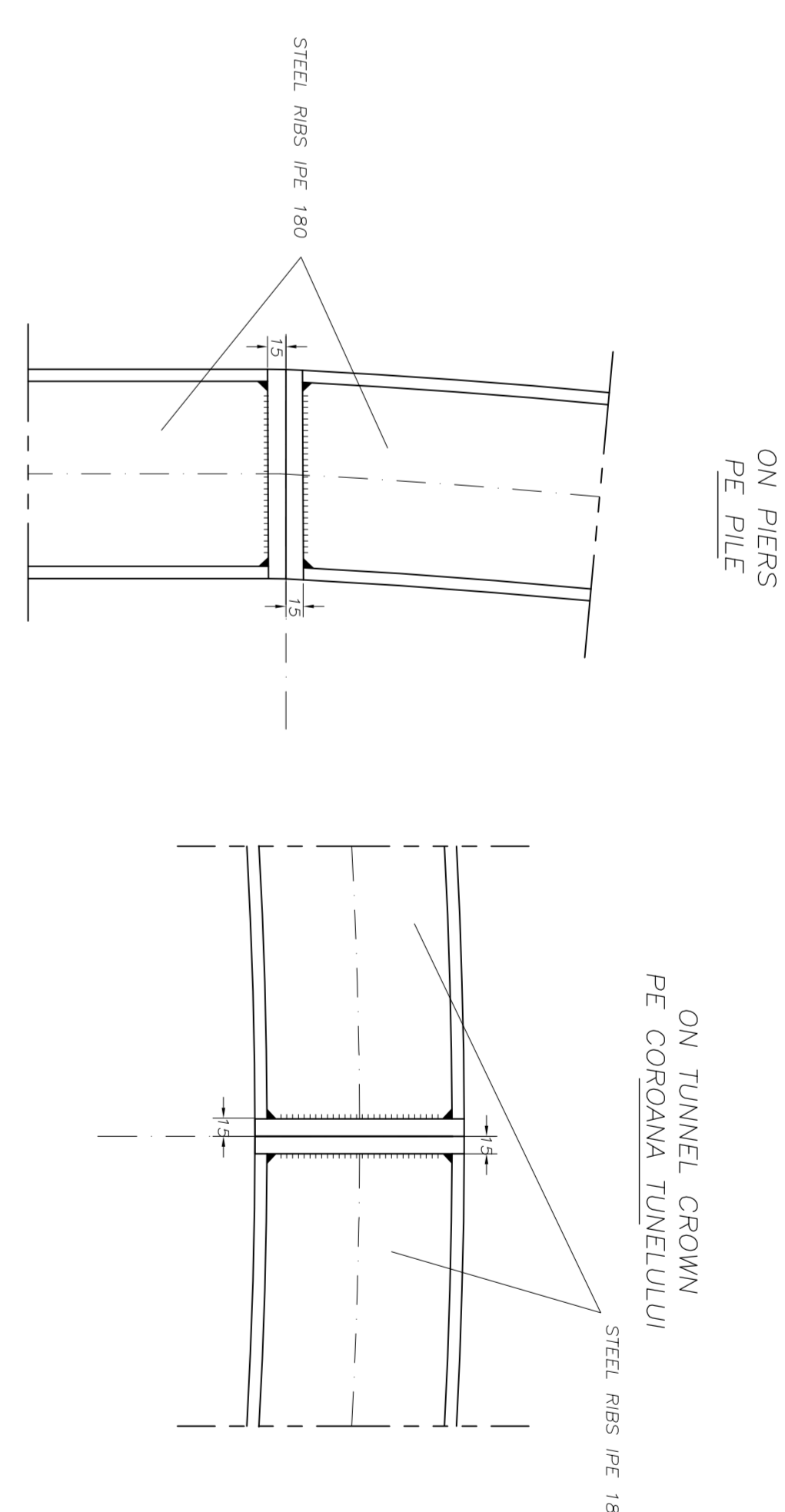

ON TUNNEL CROWN
PE CORRUGAMA TUNELULUI

DETAIL "2" DETALIU "2"

Scale/Scala 1:5

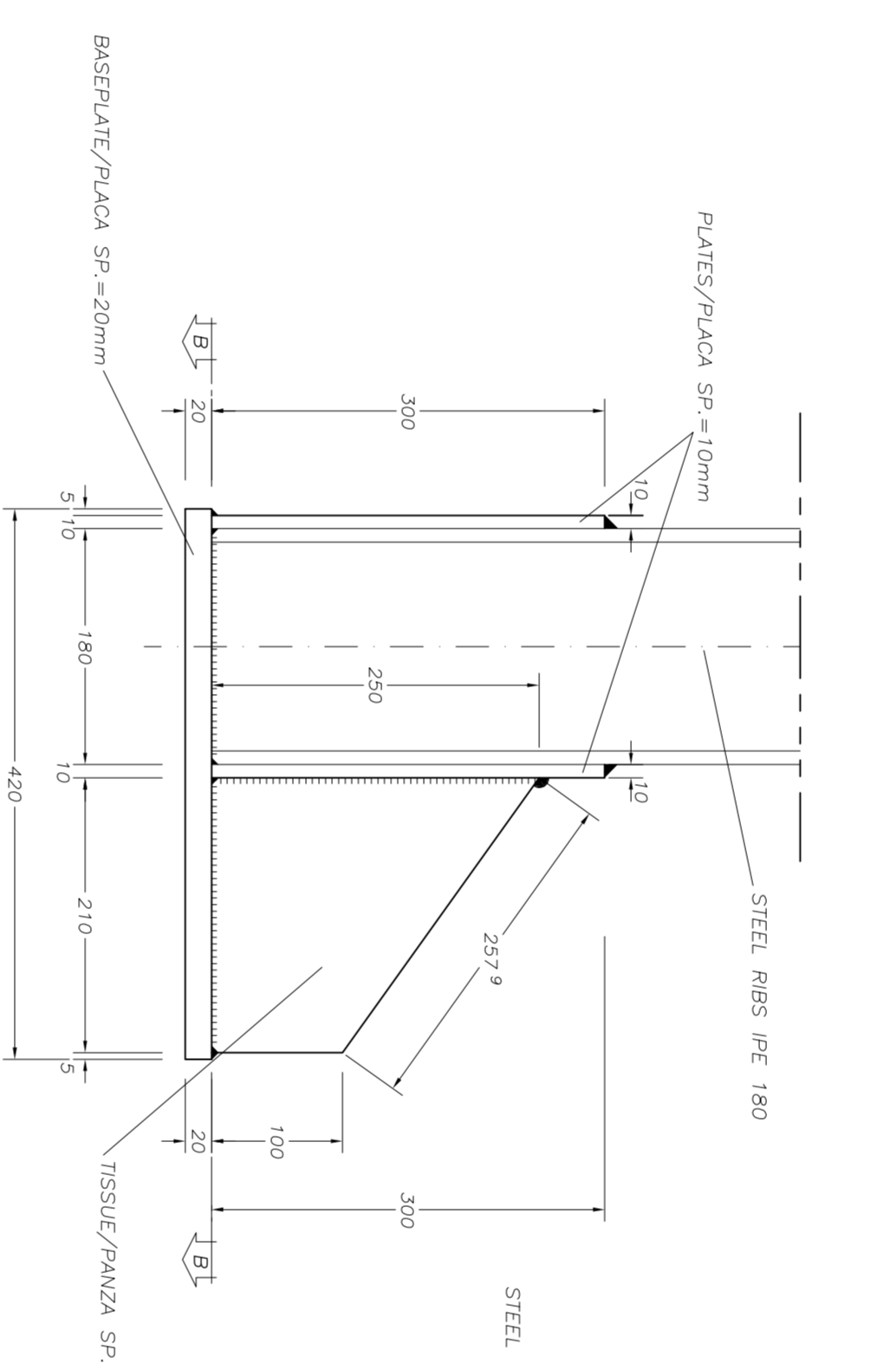

SECTION B-B SECTIUNI B-B

Scale/Scala 1:5

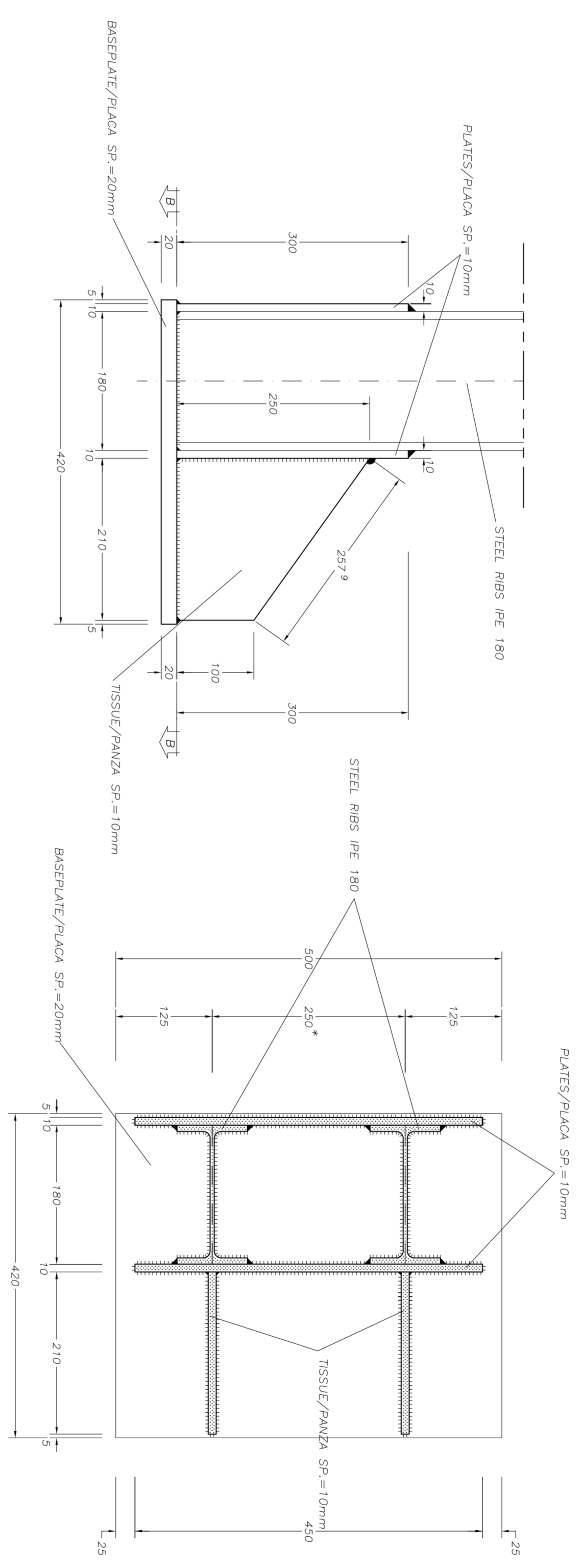

DETAIL "3" DETALIU "3"

Scale/Scala 1:5

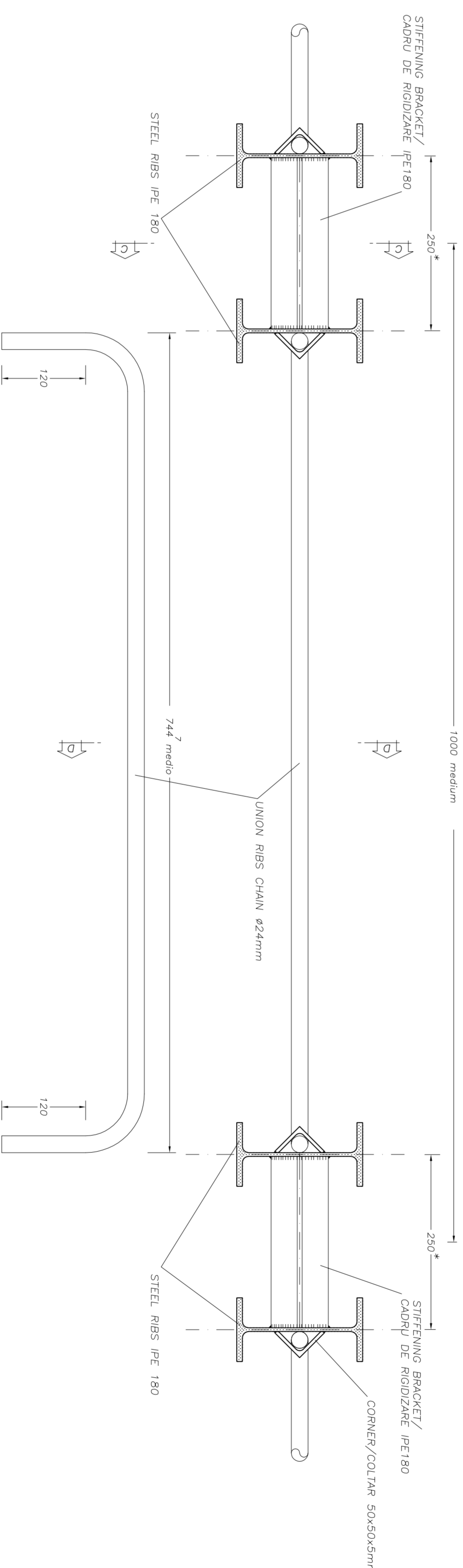

SECTION C-C SECTIUNI C-C

Scale/Scala 1:5

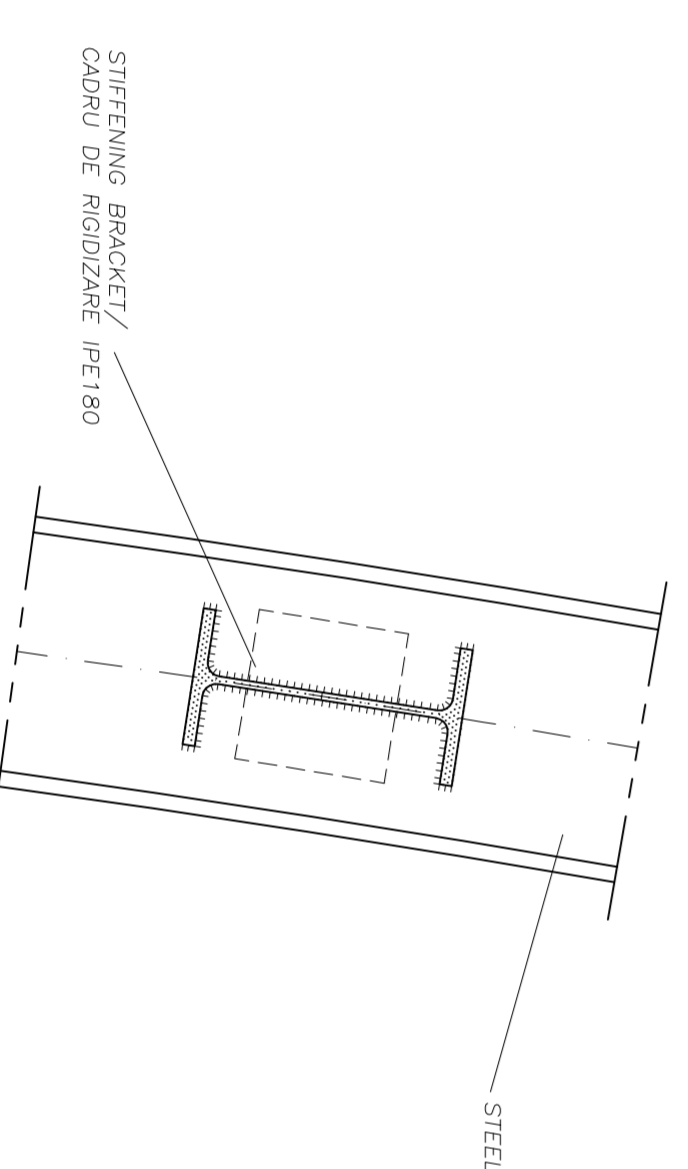

SECTION D-D SECTIUNI D-D

Scale/Scala 1:5

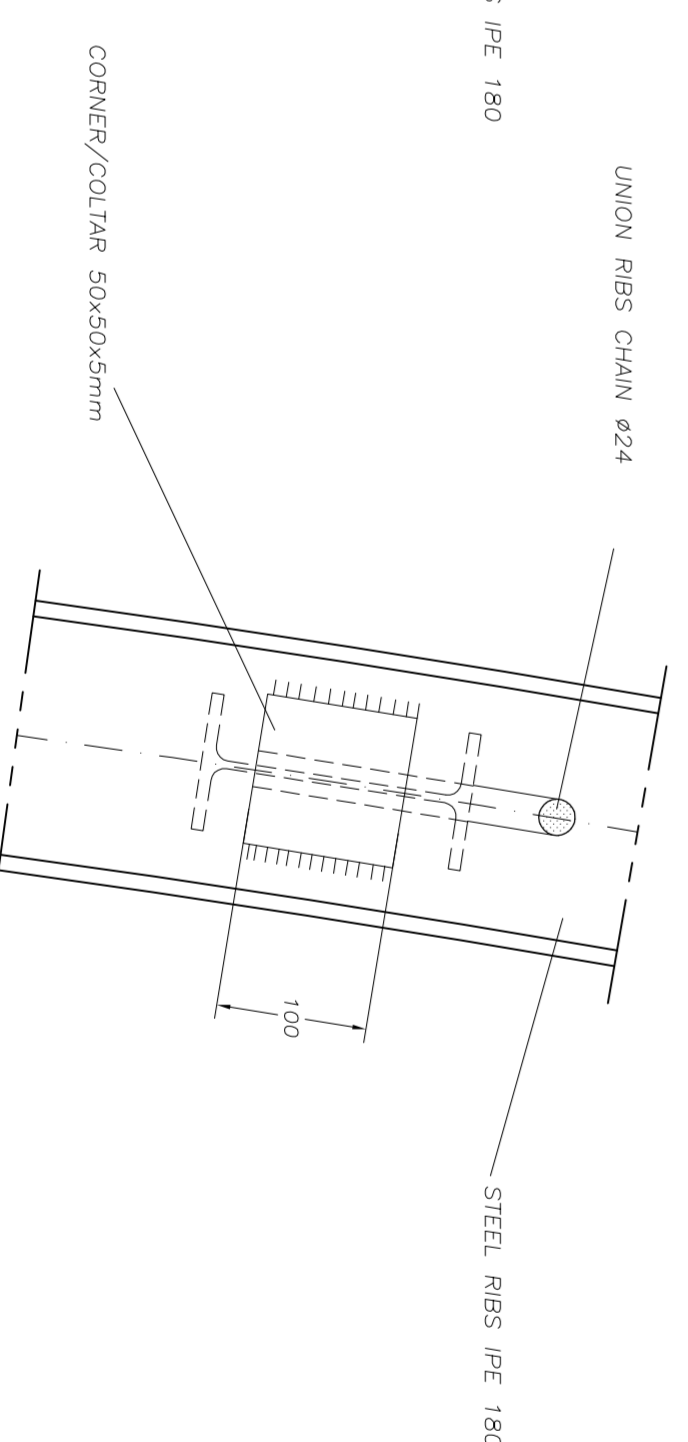

MATERIAL TABLE	
REBURI, PLACI, STIFFENING, BRACKET, CORNER:	S 275, S 430 IPE90
CHANG:	S 275, S 430 IPE90
	S 275, S 430 IPE90
	S 275, S 430 IPE90
	S 275, S 430 IPE90
	S 275, S 430 IPE90

MATERIAL TABLE	
REBURI DE OTEL, SECTIUNI CURBATE, CABRUL DE BRIDIZARE, LANGHUR:	S 275, S 430 IPE90
	S 275, S 430 IPE90
	S 275, S 430 IPE90
	S 275, S 430 IPE90
	S 275, S 430 IPE90
	S 275, S 430 IPE90

LEGEND
 RP = REFERENCE PLANE
 EX = EXCAVATIONS PLANE
 PC = CENTERS PLANE

D								
C								
B								
A								
INDEX	DATE	MODIFICATIONS	DESIGNED	APPROVED	APPROVED			
1	10.10.2017							
2								
3								
4								
5								

CLIENT / CLIENT
 CN.C.F. "C.F.R." - S.A.

CONSULTANT / CONSULTANT
 OBERMEYER
 Consulting Engineers

CONSULTANT / SUBCONSULTANT
 OREMENIS TUNNEL
 SUBCONSULTANT

DATE: 10.10.2017
 SCALE: 1:20
 PROJECT TITLE: ORMENIS TUNNEL
 DRAWING TITLE: STIFFING BRACKET, CORNER, BRACKET, CORNER

DESIGNED: R. LUTZA
 CHECKED: C. CHERNIBI
 APPROVED: C. CHERNIBI
 DATE: 10.10.2017
 SCALE: 1:20
 PROJECT TITLE: ORMENIS TUNNEL
 DRAWING TITLE: STIFFING BRACKET, CORNER, BRACKET, CORNER