

| TRASARE RADIER CULEE "C1"-fir stg | | | |
|-----------------------------------|-----------|-----------|-------|
| Pct. | X-(EST) | Y-(NORD) | Z |
| S67-C1S-R01 | 238093.55 | 592430.68 | 88.10 |
| S67-C1S-R02 | 238087.52 | 592436.67 | 88.10 |
| S67-C1S-R03 | 238095.74 | 592444.93 | 88.10 |
| S67-C1S-R04 | 238101.77 | 592438.94 | 88.10 |

| TRASARE PILOTI CULEE "C1"-fir stg | | | | |
|-----------------------------------|-----------|-----------|-------|-------|
| Pct. | X-(EST) | Y-(NORD) | Zsup | Zinf |
| S67-C1S-P01 | 238093.55 | 592432.23 | 88.20 | 66.10 |
| S67-C1S-P02 | 238091.31 | 592434.45 | 88.20 | 66.10 |
| S67-C1S-P03 | 238089.08 | 592436.68 | 88.20 | 66.10 |
| S67-C1S-P04 | 238095.77 | 592434.47 | 88.20 | 66.10 |
| S67-C1S-P05 | 238093.53 | 592436.69 | 88.20 | 66.10 |
| S67-C1S-P06 | 238091.30 | 592438.91 | 88.20 | 66.10 |
| S67-C1S-P07 | 238097.99 | 592436.70 | 88.20 | 66.10 |
| S67-C1S-P08 | 238095.75 | 592438.92 | 88.20 | 66.10 |
| S67-C1S-P09 | 238093.52 | 592441.14 | 88.20 | 66.10 |
| S67-C1S-P10 | 238100.21 | 592438.93 | 88.20 | 66.10 |
| S67-C1S-P11 | 238097.98 | 592441.15 | 88.20 | 66.10 |
| S67-C1S-P12 | 238095.74 | 592443.38 | 88.20 | 66.10 |

C1S

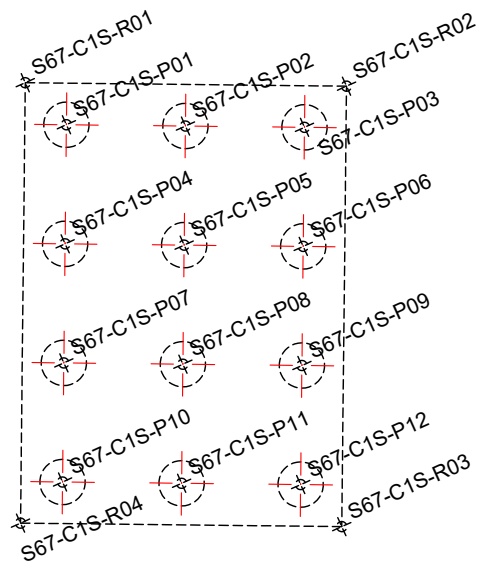

| TRASARE RADIER PILA "P1"- fir stanga | | | |
|--------------------------------------|-----------|-----------|-------|
| Pct. | Y-(EST) | X-(NORD) | Z |
| S67-P1S-R01 | 238063.46 | 592460.30 | 88.44 |
| S67-P1S-R02 | 238061.88 | 592461.84 | 88.44 |
| S67-P1S-R03 | 238070.00 | 592470.19 | 88.44 |
| S67-P1S-R04 | 238071.58 | 592468.66 | 88.44 |

| TRASARE PILOTI PILA "P1"- fir stanga | | | | |
|--------------------------------------|-----------|-----------|-------|-------|
| Pct. | Y-(EST) | X-(NORD) | Zsup | Zinf |
| S67-P1S-P01 | 238063.43 | 592461.86 | 88.54 | 66.44 |
| S67-P1S-P02 | 238065.63 | 592464.12 | 88.54 | 66.44 |
| S67-P1S-P03 | 238067.83 | 592466.38 | 88.54 | 66.44 |
| S67-P1S-P04 | 238070.02 | 592468.64 | 88.54 | 66.44 |

P1S

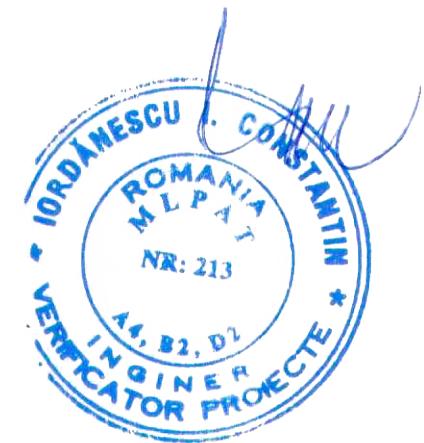
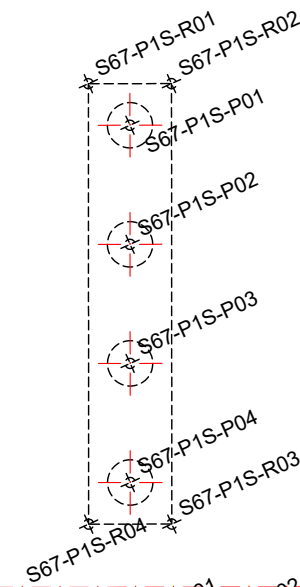

| TRASARE RADIER CULEE "C1"-fir dr | | | |
|----------------------------------|-----------|-----------|-------|
| Pct. | X-(EST) | Y-(NORD) | Z |
| S67-CD1-R01 | 238104.13 | 592441.31 | 88.10 |
| S67-CD1-R02 | 238098.10 | 592447.31 | 88.10 |
| S67-CD1-R03 | 238106.32 | 592455.57 | 88.10 |
| S67-CD1-R04 | 238112.34 | 592449.57 | 88.10 |

| TRASARE PILOTI CULEE "C1"-fir dr | | | | |
|----------------------------------|-----------|-----------|-------|-------|
| Pct. | X-(EST) | Y-(NORD) | Zsup | Zinf |
| S67-CD1-P01 | 238104.12 | 592442.87 | 88.20 | 66.10 |
| S67-CD1-P02 | 238101.89 | 592445.09 | 88.20 | 66.10 |
| S67-CD1-P03 | 238099.66 | 592447.31 | 88.20 | 66.10 |
| S67-CD1-P04 | 238106.35 | 592445.10 | 88.20 | 66.10 |
| S67-CD1-P05 | 238104.11 | 592447.32 | 88.20 | 66.10 |
| S67-CD1-P06 | 238101.88 | 592449.54 | 88.20 | 66.10 |
| S67-CD1-P07 | 238108.57 | 592447.33 | 88.20 | 66.10 |
| S67-CD1-P08 | 238106.33 | 592449.56 | 88.20 | 66.10 |
| S67-CD1-P09 | 238104.10 | 592451.78 | 88.20 | 66.10 |
| S67-CD1-P10 | 238110.79 | 592449.57 | 88.20 | 66.10 |
| S67-CD1-P11 | 238108.55 | 592451.79 | 88.20 | 66.10 |
| S67-CD1-P12 | 238106.32 | 592454.01 | 88.20 | 66.10 |

CD1

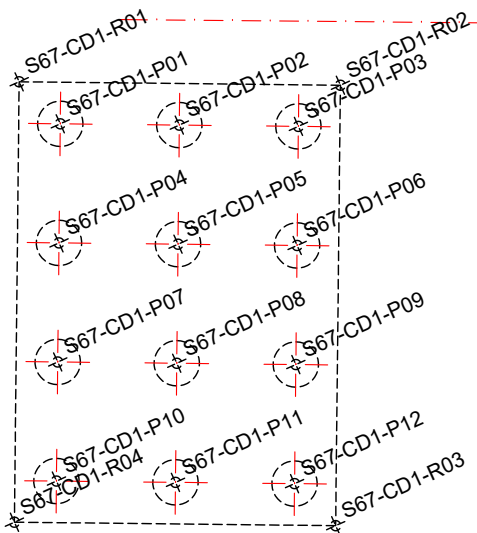

| TRASARE RADIER PILA "P1"- fir dreapta | | | |
|---------------------------------------|-----------|-----------|-------|
| Pct. | Y-(EST) | X-(NORD) | Z |
| S67-PD1-R01 | 238073.91 | 592471.06 | 88.44 |
| S67-PD1-R02 | 238072.33 | 592472.59 | 88.44 |
| S67-PD1-R03 | 238080.45 | 592480.95 | 88.44 |
| S67-PD1-R04 | 238082.03 | 592479.41 | 88.44 |

| TRASARE PILOTI PILA "P1"- fir dreapta | | | | |
|---------------------------------------|-----------|-----------|-------|-------|
| Pct. | Y-(EST) | X-(NORD) | Zsup | Zinf |
| S67-PD1-P01 | 238073.89 | 592472.61 | 88.54 | 66.44 |
| S67-PD1-P02 | 238076.09 | 592474.87 | 88.54 | 66.44 |
| S67-PD1-P03 | 238078.28 | 592477.13 | 88.54 | 66.44 |
| S67-PD1-P04 | 238080.48 | 592479.39 | 88.54 | 66.44 |

PD1

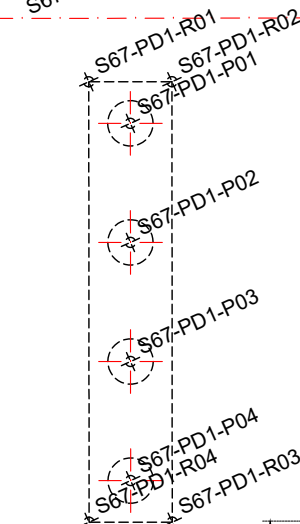

Granița HU/
HU Border

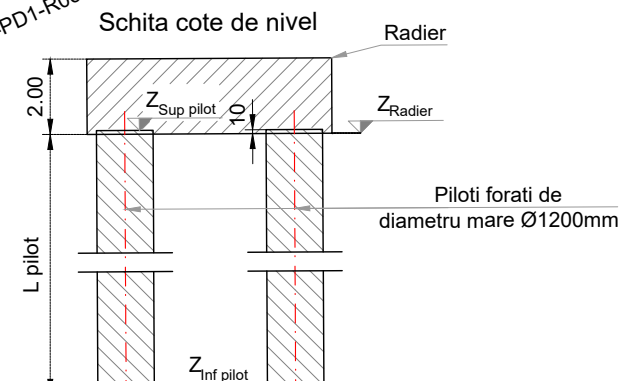

PROIECTANT / DESIGNER:
S.C. CONSITRANS S.R.L.



BENEFICIAR / BENEFICIARY:
MUNICIPIUL ARAD, MUNICIPIUL ORADEA, CONSILIUL JUDETEAN ARAD, CONSILIUL JUDETEAN BIHOR CNAIR

FUNCTIA / POSITION:
COORDONATOR DE PROIECT / PROJECT MANAGER
NUME / NAME:
ing. S. VEACESLAV

SEMNETURA / SIGNATURE:
[Signature]

Titlu plansa / Drawing title:
Plan trasare - plan 1 / 8
Layout plan - drawing 1 / 8

| REV. / REV. | DATA / DATE | DETALII REVIZIE / REVISION DETAILS | PROIECTAT / DESIGNER |
|-------------|-------------|------------------------------------|----------------------|
| R00 | 11.2023 | P.T.E. | Consitrans |

INVESTITIA / INVESTMENT:
ACTUALIZARE/COMPLETARE/REVIZUIRE (S.F. + P.A.C. + P.O.E + P.T.E.) "DRUM EXPRES ARAD ORADEA"
ACTUALIZATION/COMPLETION (S.F. + P.A.C. + P.O.E + P.T.E.) "EXPRESS ROAD ARAD ORADEA"

SEF PROIECT SPECIALITATE / TEAM LEADER
ing. D. COVELTIR
[Signature]

Pasaj pe DL HU la km 4+870 peste CF si DN79B
Bridge on DL HU at km 4+870 over CF and DN79B

| REV. / REV. | DATA / DATE | DETALII REVIZIE / REVISION DETAILS | PROIECTAT / DESIGNER |
|-------------|-------------|------------------------------------|----------------------|
| | | | |



PROIECT CO-FINANȚAT DIN FONDUL DE COEZIUNE, PRIN PROGRAMUL OPERAȚIONAL INFRASTRUCTURĂ MARE / PROJECT CO-FINANANCED FROM THE COHESION FUND, THROUGH THE LARGE INFRASTRUCTURE OPERATIONAL PROGRAM

FAZA PROIECTARE / DESIGN STAGE:
PROIECT TEHNIC DE EXECUTIE / EXECUTION TECHNICAL PROJECT
Contract / Contract: 14724/01.07.2021
Data / Date: 11.2023
Scara / Scale: 1:200

PROIECTAT / DESIGNER:
ing. V. URDAREANU
[Signature]
VERIFICAT / INTERNAL CHECKER:
ing. D. COVELTIR
[Signature]

LUCRARI DE POD / BRIDGE WORKS
Cod plansa / Drawing code:
CST-0121-PTE-0-DX- 02-P67-PTR-01-R00

| REV. / REV. | DATA / DATE | DETALII REVIZIE / REVISION DETAILS | PROIECTAT / DESIGNER |
|-------------|-------------|------------------------------------|----------------------|
| | | | |



PS2

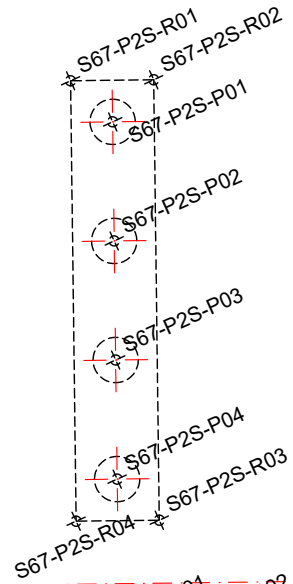

| TRASARE RADIER PILA "P2"- fir stanga | | | |
|--------------------------------------|-----------|-----------|-------|
| Pct. | Y-(EST) | X-(NORD) | Z |
| S67-P2S-R01 | 238033.66 | 592488.94 | 88.37 |
| S67-P2S-R02 | 238032.07 | 592490.46 | 88.37 |
| S67-P2S-R03 | 238040.09 | 592498.90 | 88.37 |
| S67-P2S-R04 | 238041.68 | 592497.39 | 88.37 |

| TRASARE PILOTI PILA "P2"- fir stanga | | | | |
|--------------------------------------|-----------|-----------|-------|-------|
| Pct. | Y-(EST) | X-(NORD) | Zsup | Zinf |
| S67-P2S-P01 | 238033.62 | 592490.50 | 88.47 | 66.37 |
| S67-P2S-P02 | 238035.79 | 592492.78 | 88.47 | 66.37 |
| S67-P2S-P03 | 238037.96 | 592495.06 | 88.47 | 66.37 |
| S67-P2S-P04 | 238040.13 | 592497.35 | 88.47 | 66.37 |

| TRASARE RADIER PILA "P2"- fir dreapta | | | |
|---------------------------------------|-----------|-----------|-------|
| Pct. | Y-(EST) | X-(NORD) | Z |
| S67-PD2-R01 | 238043.99 | 592499.82 | 88.37 |
| S67-PD2-R02 | 238042.4 | 592501.33 | 88.37 |
| S67-PD2-R03 | 238050.42 | 592509.78 | 88.37 |
| S67-PD2-R04 | 238052.01 | 592508.27 | 88.37 |

| TRASARE PILOTI PILA "P2"- fir dreapta | | | | |
|---------------------------------------|-----------|-----------|-------|-------|
| Pct. | Y-(EST) | X-(NORD) | Zsup | Zinf |
| S67-PD2-P01 | 238043.95 | 592501.37 | 88.47 | 66.37 |
| S67-PD2-P02 | 238046.12 | 592503.66 | 88.47 | 66.37 |
| S67-PD2-P03 | 238048.29 | 592505.94 | 88.47 | 66.37 |
| S67-PD2-P04 | 238050.46 | 592508.23 | 88.47 | 66.37 |

PD2

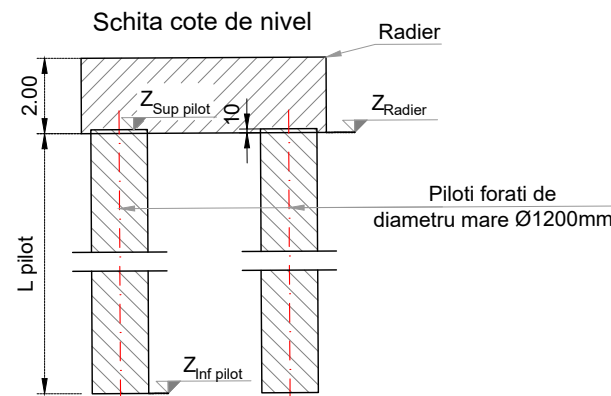
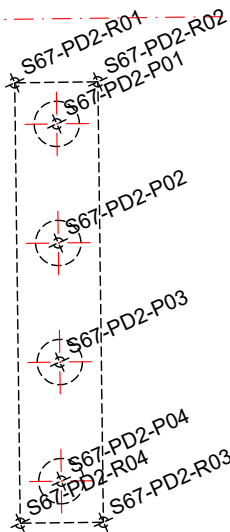

PS3

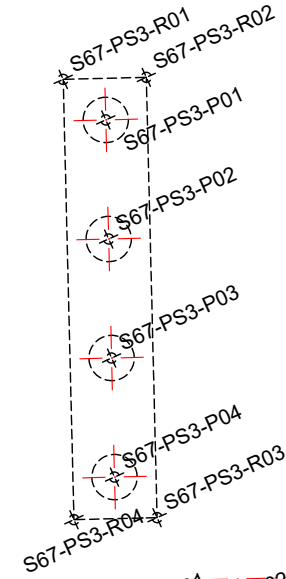

| TRASARE RADIER PILA "P3"- fir stanga | | | |
|--------------------------------------|-----------|-----------|-------|
| Pct. | Y-(EST) | X-(NORD) | Z |
| S67-PS3-R01 | 238003.53 | 592517.22 | 88.72 |
| S67-PS3-R02 | 238001.92 | 592518.72 | 88.72 |
| S67-PS3-R03 | 238009.84 | 592527.26 | 88.72 |
| S67-PS3-R04 | 238011.45 | 592525.77 | 88.72 |

| TRASARE PILOTI PILA "P3"- fir stanga | | | | |
|--------------------------------------|-----------|-----------|-------|-------|
| Pct. | Y-(EST) | X-(NORD) | Zsup | Zinf |
| S67-PS3-P01 | 238003.48 | 592518.78 | 88.82 | 66.72 |
| S67-PS3-P02 | 238005.62 | 592521.09 | 88.82 | 66.72 |
| S67-PS3-P03 | 238007.76 | 592523.40 | 88.82 | 66.72 |
| S67-PS3-P04 | 238009.90 | 592525.71 | 88.82 | 66.72 |

| TRASARE RADIER PILA "P3"- fir dreapta | | | |
|---------------------------------------|-----------|-----------|-------|
| Pct. | Y-(EST) | X-(NORD) | Z |
| S67-PD3-R01 | 238013.73 | 592528.22 | 88.72 |
| S67-PD3-R02 | 238012.12 | 592529.72 | 88.72 |
| S67-PD3-R03 | 238020.04 | 592538.26 | 88.72 |
| S67-PD3-R04 | 238021.65 | 592536.77 | 88.72 |

| TRASARE PILOTI PILA "P3"- fir dreapta | | | | |
|---------------------------------------|-----------|-----------|-------|-------|
| Pct. | Y-(EST) | X-(NORD) | Zsup | Zinf |
| S67-PD3-P01 | 238013.67 | 592529.78 | 88.82 | 66.72 |
| S67-PD3-P02 | 238015.81 | 592532.09 | 88.82 | 66.72 |
| S67-PD3-P03 | 238017.96 | 592534.40 | 88.82 | 66.72 |
| S67-PD3-P04 | 238020.10 | 592536.71 | 88.82 | 66.72 |

PD3

Granița HU/
HU Border



PROIECTANT / DESIGNER:
S.C. CONSITRANS S.R.L.



BENEFICIAR / BENEFICIARY:
MUNICIPIUL ARAD, MUNICIPIUL ORADEA, CONSILIUL JUDETEAN ARAD, CONSILIUL JUDETEAN BIHOR CNAIR

FUNCTIA / POSITION:
COORDONATOR DE PROIECT / PROJECT MANAGER

NUME / NAME:
ing. S. VEACESLAV

SEMNATURA / SIGNATURE:
[Signature]

Titlu plansa / Drawing title:
Plan trasare - plan 2 / 8
Layout plan - drawing 2 / 8

REV. / REV.:
R00

DATA / DATE:
11.2023

DETALII REVIZIE / REVISION DETAILS:
P.T.E.

PROIECTAT / DESIGNER:
Consitrans

INVESTITIA / INVESTMENT:
ACTUALIZARE/COMPLETARE/REVIZUIRE (S.F. + P.A.C. + P.O.E + P.T.E.) "DRUM EXPRES ARAD ORADEA"
ACTUALIZATION/COMPLETION (S.F. + P.A.C. + P.O.E + P.T.E.) "EXPRESS ROAD ARAD ORADEA"

SEF PROIECT SPECIALITATE / TEAM LEADER
ing. D. COVELTIR

SEMNATURA / SIGNATURE:
[Signature]

Pasaj pe DL HU la km 4+870 peste CF si DN79B
Bridge on DL HU at km 4+870 over CF and DN79B

FAZA PROIECTARE / DESIGN STAGE:
PROIECT TEHNIC DE EXECUTIE / EXECUTION TECHNICAL PROJECT

PROIECTAT / DESIGNER:
ing. V. URDAREANU

SEMNATURA / SIGNATURE:
[Signature]

LUCRARI DE POD / BRIDGE WORKS

Contract / Contract:
14724/01.07.2021
Data / Date:
11.2023
Scara / Scale:
1:200

VERIFICAT / INTERNAL CHECKER:
ing. D. COVELTIR

SEMNATURA / SIGNATURE:
[Signature]

Cod plansa / Drawing code:
CST-0121-PTE-0-DX- 02-P67-PTR-02-R00



UNIUNEA EUROPEANA



GUVERNUL ROMANIEI



Instrumente Structurale 2014-2020

PROIECT CO-FINANȚAT DIN FONDUL DE COEZIUNE, PRIN PROGRAMUL OPERAȚIONAL INFRASTRUCTURĂ MARE / PROJECT CO-FINANCED FROM THE COHESION FUND, THROUGH THE LARGE INFRASTRUCTURE OPERATIONAL PROGRAM

| TRASARE RADIER PILA "P4"- fir stanga | | | |
|--------------------------------------|-----------|-----------|-------|
| Pct. | Y-(EST) | X-(NORD) | Z |
| S67-PS4-R01 | 237974.56 | 592543.83 | 88.27 |
| S67-PS4-R02 | 237970.70 | 592547.32 | 88.27 |
| S67-PS4-R03 | 237978.49 | 592555.92 | 88.27 |
| S67-PS4-R07 | 237982.34 | 592552.43 | 88.27 |

| TRASARE PILOTI PILA "P4"- fir stanga | | | | |
|--------------------------------------|-----------|-----------|-------|-------|
| Pct. | Y-(EST) | X-(NORD) | Zsup | Zinf |
| S67-PS4-P01 | 237974.46 | 592545.37 | 88.37 | 66.27 |
| S67-PS4-P02 | 237972.24 | 592547.38 | 88.37 | 66.27 |
| S67-PS4-P03 | 237976.58 | 592547.70 | 88.37 | 66.27 |
| S67-PS4-P04 | 237974.35 | 592549.72 | 88.37 | 66.27 |
| S67-PS4-P05 | 237978.69 | 592550.04 | 88.37 | 66.27 |
| S67-PS4-P06 | 237976.47 | 592552.05 | 88.37 | 66.27 |
| S67-PS4-P07 | 237980.80 | 592552.37 | 88.37 | 66.27 |
| S67-PS4-P08 | 237978.58 | 592554.39 | 88.37 | 66.27 |

| TRASARE RADIER PILA "P4"- fir dreapta | | | |
|---------------------------------------|-----------|-----------|-------|
| Pct. | Y-(EST) | X-(NORD) | Z |
| S67-PD4-R01 | 237984.62 | 592554.95 | 88.27 |
| S67-PD4-R02 | 237980.77 | 592558.44 | 88.27 |
| S67-PD4-R03 | 237988.55 | 592567.04 | 88.27 |
| S67-PD4-R04 | 237992.41 | 592563.55 | 88.27 |

| TRASARE PILOTI PILA "P4"- fir dreapta | | | | |
|---------------------------------------|-----------|-----------|-------|-------|
| Pct. | Y-(EST) | X-(NORD) | Zsup | Zinf |
| S67-PD4-P01 | 237984.53 | 592556.49 | 88.37 | 66.27 |
| S67-PD4-P02 | 237982.31 | 592558.50 | 88.37 | 66.27 |
| S67-PD4-P03 | 237986.64 | 592558.82 | 88.37 | 66.27 |
| S67-PD4-P04 | 237984.42 | 592560.84 | 88.37 | 66.27 |
| S67-PD4-P05 | 237988.76 | 592561.16 | 88.37 | 66.27 |
| S67-PD4-P06 | 237986.53 | 592563.17 | 88.37 | 66.27 |
| S67-PD4-P07 | 237990.87 | 592563.49 | 88.37 | 66.27 |
| S67-PD4-P08 | 237988.65 | 592565.51 | 88.37 | 66.27 |

PS4

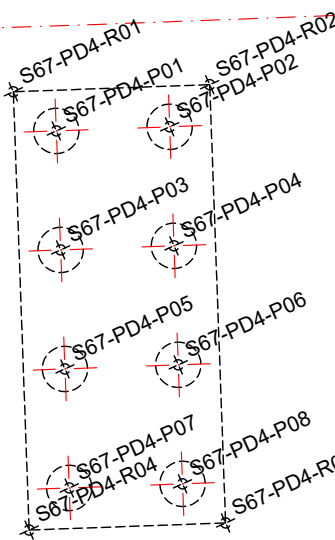
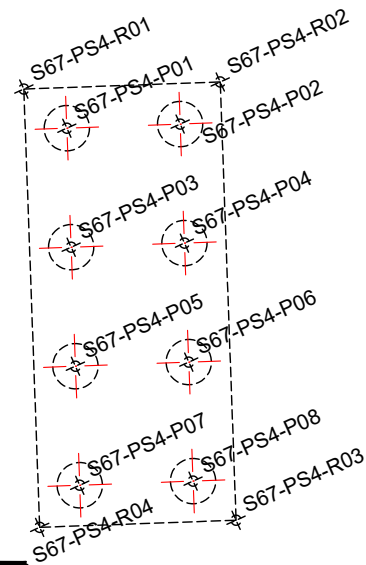

PD4



| TRASARE RADIER PILA "P5"- fir stanga | | | |
|--------------------------------------|-----------|-----------|-------|
| Pct. | Y-(EST) | X-(NORD) | Z |
| S67-PS5-R01 | 237943.00 | 592572.07 | 88.19 |
| S67-PS5-R02 | 237941.35 | 592573.53 | 88.19 |
| S67-PS5-R03 | 237949.07 | 592582.25 | 88.19 |
| S67-PS5-R04 | 237950.72 | 592580.80 | 88.19 |

| TRASARE PILOTI PILA "P5"- fir stanga | | | | |
|--------------------------------------|-----------|-----------|-------|-------|
| Pct. | Y-(EST) | X-(NORD) | Zsup | Zinf |
| S67-PS5-P01 | 237942.90 | 592573.62 | 88.29 | 66.19 |
| S67-PS5-P02 | 237944.99 | 592575.98 | 88.29 | 66.19 |
| S67-PS5-P03 | 237947.08 | 592578.34 | 88.29 | 66.19 |
| S67-PS5-P04 | 237949.16 | 592580.70 | 88.29 | 66.19 |

PS5

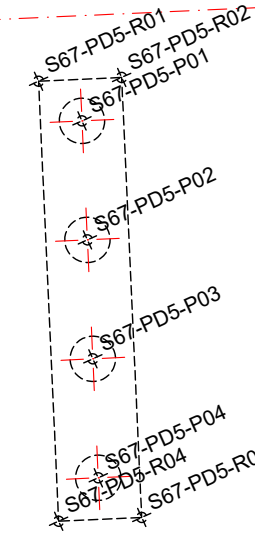
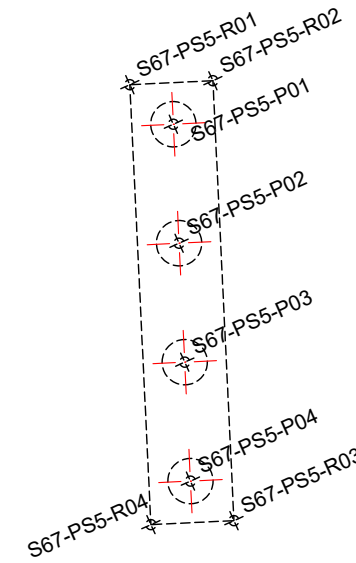

PD5

| TRASARE RADIER PILA "P5"- fir dreapta | | | |
|---------------------------------------|-----------|-----------|-------|
| Pct. | Y-(EST) | X-(NORD) | Z |
| S67-PD5-R01 | 237958.95 | 592577.97 | 88.66 |
| S67-PD5-R02 | 237957.30 | 592579.43 | 88.66 |
| S67-PD5-R03 | 237965.04 | 592588.14 | 88.66 |
| S67-PD5-R04 | 237966.68 | 592586.68 | 88.66 |

| TRASARE PILOTI PILA "P5"- fir dreapta | | | | |
|---------------------------------------|-----------|-----------|-------|-------|
| Pct. | Y-(EST) | X-(NORD) | Zsup | Zinf |
| S67-PD5-P01 | 237958.86 | 592579.53 | 88.76 | 66.66 |
| S67-PD5-P02 | 237960.95 | 592581.88 | 88.76 | 66.66 |
| S67-PD5-P03 | 237963.04 | 592584.24 | 88.76 | 66.66 |
| S67-PD5-P04 | 237965.13 | 592586.59 | 88.76 | 66.66 |



Granița HU/
HU Border

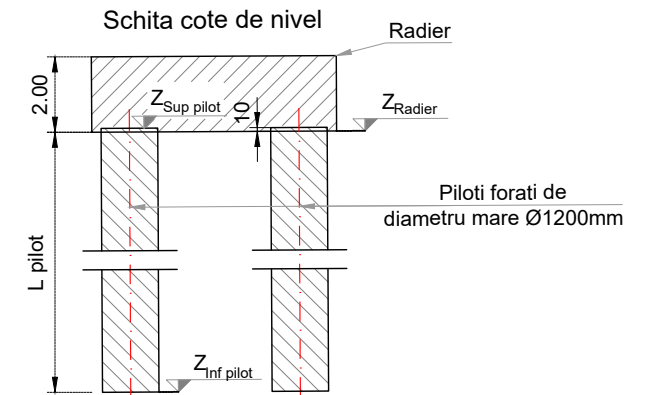

PROIECTANT / DESIGNER:
S.C. CONSITRANS S.R.L.



BENEFICIAR / BENEFICIARY:
MUNICIPIUL ARAD, MUNICIPIUL ORADEA, CONSILIUL JUDETEAN ARAD, CONSILIUL JUDETEAN BIHOR CNAIR

FUNCTIA / POSITION:
COORDONATOR DE PROIECT / PROJECT MANAGER

NUME / NAME:
ing. S. VEACESLAV

SEMNTURA / SIGNATURE:
[Signature]

Titlu plansa / Drawing title:
Plan trasare - plan 3 / 8
Layout plan - drawing 3 / 8

REV. / REV.:
R00

DATA / DATE:
11.2023

DETALII REVIZIE / REVISION DETAILS:
P.T.E.

PROIECTAT / DESIGNER:
Consitrans

INVESTITIA / INVESTMENT:
ACTUALIZARE/COMPLETARE/REVIZUIRE (S.F. + P.A.C. + P.O.E + P.T.E.) "DRUM EXPRES ARAD ORADEA"
ACTUALIZATION/COMPLETION (S.F. + P.A.C. + P.O.E + P.T.E.) "EXPRESS ROAD ARAD ORADEA"

SEF PROIECT SPECIALITATE / TEAM LEADER
ing. D. COVELTIR

SEMNTURA / SIGNATURE:
[Signature]

Pasaj pe DL HU la km 4+870 peste CF si DN79B
Bridge on DL HU at km 4+870 over CF and DN79B

REV. / REV.:
R00

DATA / DATE:
11.2023

DETALII REVIZIE / REVISION DETAILS:
P.T.E.

PROIECTAT / DESIGNER:
Consitrans

FAZA PROIECTARE / DESIGN STAGE:
PROIECT TEHNIC DE EXECUTIE / EXECUTION TECHNICAL PROJECT

PROIECTAT / DESIGNER:
ing. V. URDAREANU

SEMNTURA / SIGNATURE:
[Signature]

LUCRARI DE POD / BRIDGE WORKS

REV. / REV.:
R00

DATA / DATE:
11.2023

DETALII REVIZIE / REVISION DETAILS:
P.T.E.

PROIECTAT / DESIGNER:
Consitrans

Contract /Contract:
14724/01.07.2021
Project /Project no.:
001/2021

VERIFICAT / INTERNAL CHECKER:
ing. D. COVELTIR

SEMNTURA / SIGNATURE:
[Signature]

Cod plansa / Drawing code:
CST-0121-PTE-0-DX- 02-P67-PTR-03-R00

REV. / REV.:
R00

DATA / DATE:
11.2023

DETALII REVIZIE / REVISION DETAILS:
P.T.E.

PROIECTAT / DESIGNER:
Consitrans



UNIUNEA EUROPEANA



GUVERNUL ROMANIEI



Instrumente Structurale 2014-2020

PROIECT CO-FINANȚAT DIN FONDUL DE COEZIUNE, PRIN PROGRAMUL OPERAȚIONAL INFRASTRUCTURĂ MARE / PROJECT CO-FINANCED FROM THE COHESION FUND, THROUGH THE LARGE INFRASTRUCTURE OPERATIONAL PROGRAM

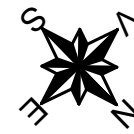

| TRASARE RADIER PILA "P6"- fir stanga | | | | |
|--------------------------------------|-----------|-----------|-------|-------|
| Pct. | Y-(EST) | X-(NORD) | Z | |
| S67-PS6-R01 | 237911.89 | 592599.27 | 88.31 | |
| S67-PS6-R02 | 237910.22 | 592600.71 | 88.31 | |
| S67-PS6-R03 | 237917.84 | 592609.53 | 88.31 | |
| S67-PS6-R04 | 237919.50 | 592608.09 | 88.31 | |
| TRASARE PILOTI PILA "P6"- fir stanga | | | | |
| Pct. | Y-(EST) | X-(NORD) | Zsup | Zinf |
| S67-PS6-P01 | 237911.78 | 592600.82 | 88.41 | 66.31 |
| S67-PS6-P02 | 237913.83 | 592603.21 | 88.41 | 66.31 |
| S67-PS6-P03 | 237915.89 | 592605.59 | 88.41 | 66.31 |
| S67-PS6-P04 | 237917.95 | 592607.97 | 88.41 | 66.31 |

PS6

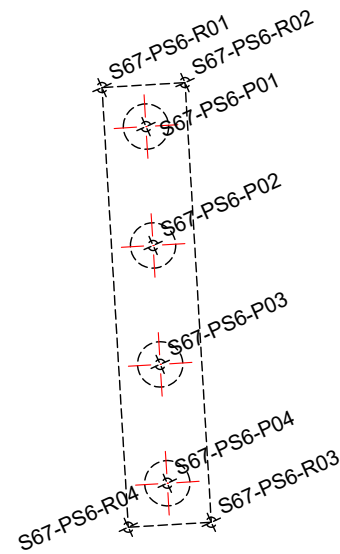

| TRASARE RADIER PILA "P7"- fir stanga | | | | |
|--------------------------------------|-----------|-----------|-------|-------|
| Pct. | Y-(EST) | X-(NORD) | Z | |
| S67-PS7-R01 | 237880.46 | 592626.10 | 88.35 | |
| S67-PS7-R02 | 237878.78 | 592627.52 | 88.35 | |
| S67-PS7-R03 | 237886.29 | 592636.43 | 88.35 | |
| S67-PS7-R04 | 237887.97 | 592635.01 | 88.35 | |
| TRASARE PILOTI PILA "P7"- fir stanga | | | | |
| Pct. | Y-(EST) | X-(NORD) | Zsup | Zinf |
| S67-PS7-P01 | 237880.33 | 592627.65 | 88.45 | 66.35 |
| S67-PS7-P02 | 237882.36 | 592630.06 | 88.45 | 66.35 |
| S67-PS7-P03 | 237884.39 | 592632.47 | 88.45 | 66.35 |
| S67-PS7-P04 | 237886.42 | 592634.88 | 88.45 | 66.35 |

PS7

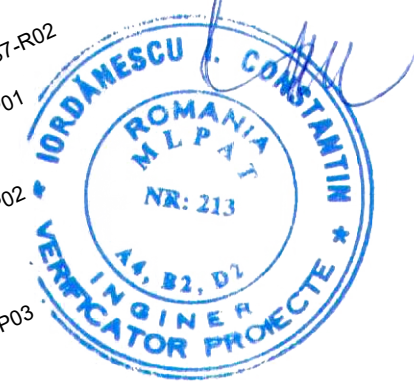
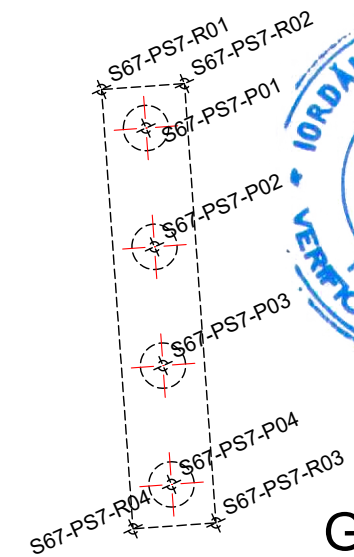

**Granita HU/
HU Border**

DX

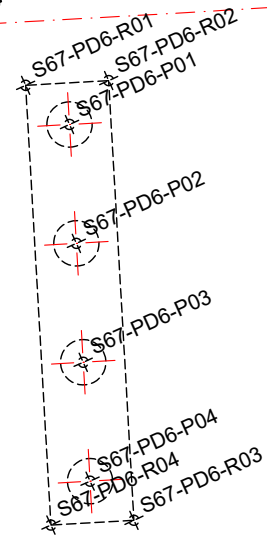

PD6

| TRASARE RADIER PILA "P6"- fir dreapta | | | | |
|---------------------------------------|-----------|-----------|-------|-------|
| Pct. | Y-(EST) | X-(NORD) | Z | |
| S67-PD6-R01 | 237927.77 | 592605.36 | 88.29 | |
| S67-PD6-R02 | 237926.10 | 592606.80 | 88.29 | |
| S67-PD6-R03 | 237933.74 | 592615.60 | 88.29 | |
| S67-PD6-R04 | 237935.40 | 592614.16 | 88.29 | |
| TRASARE PILOTI PILA "P6"- fir dreapta | | | | |
| Pct. | Y-(EST) | X-(NORD) | Zsup | Zinf |
| S67-PD6-P01 | 237927.66 | 592606.91 | 88.39 | 66.29 |
| S67-PD6-P02 | 237929.72 | 592609.29 | 88.39 | 66.29 |
| S67-PD6-P03 | 237931.78 | 592611.67 | 88.39 | 66.29 |
| S67-PD6-P04 | 237933.85 | 592614.05 | 88.39 | 66.29 |

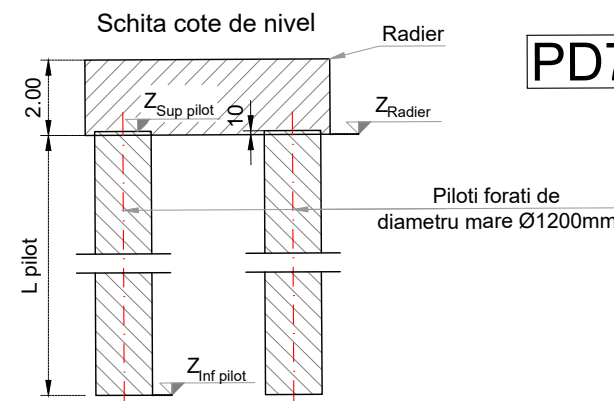

PD7

| TRASARE RADIER PILA "P7"- fir dreapta | | | | |
|---------------------------------------|-----------|-----------|-------|-------|
| Pct. | Y-(EST) | X-(NORD) | Z | |
| S67-PD7-R01 | 237896.26 | 592632.38 | 88.35 | |
| S67-PD7-R02 | 237894.59 | 592633.80 | 88.35 | |
| S67-PD7-R03 | 237902.11 | 592642.69 | 88.35 | |
| S67-PD7-R04 | 237903.79 | 592641.27 | 88.35 | |
| TRASARE PILOTI PILA "P7"- fir dreapta | | | | |
| Pct. | Y-(EST) | X-(NORD) | Zsup | Zinf |
| S67-PD7-P01 | 237896.14 | 592633.93 | 88.45 | 66.35 |
| S67-PD7-P02 | 237898.17 | 592636.33 | 88.45 | 66.35 |
| S67-PD7-P03 | 237900.21 | 592638.74 | 88.45 | 66.35 |
| S67-PD7-P04 | 237902.24 | 592641.14 | 88.45 | 66.35 |

PROIECTANT / DESIGNER:
S.C. CONSITRANS S.R.L.



BENEFICIAR / BENEFICIARY:
MUNICIPIUL ARAD, MUNICIPIUL ORADEA, CONSILIUL JUDETEAN ARAD, CONSILIUL JUDETEAN BIHOR CNAIR

FUNCTIA / POSITION:
COORDONATOR DE PROIECT / PROJECT MANAGER

NUME / NAME:
ing. S. VEACESLAV

SEMNTURA / SIGNATURE:
[Signature]

Titlu plansa / Drawing title:
Plan trasare - plan 4 / 8
Layout plan - drawing 4 / 8

REV. / REV.:
R00

DATA / DATE:
11.2023

DETALII REVIZIE / REVISION DETAILS:
P.T.E.

PROIECTAT / DESIGNER:
Consitrans

INVESTITIA / INVESTMENT:
ACTUALIZARE/COMPLETARE/REVIZUIRE (S.F. + P.A.C. + P.O.E + P.T.E.) "DRUM EXPRES ARAD ORADEA"
ACTUALIZATION/COMPLETION (S.F. + P.A.C. + P.O.E + P.T.E.) "EXPRESS ROAD ARAD ORADEA"

SEF PROIECT SPECIALITATE / TEAM LEADER
ing. D. COVELTIR

SEMNTURA / SIGNATURE:
[Signature]

Pasaj pe DL HU la km 4+870 peste CF si DN79B
Bridge on DL HU at km 4+870 over CF and DN79B

PROIECTAT / DESIGNER:
ing. V. URDAREANU



PROIECT CO-FINANAT DIN FONDUL DE COEZIUNE, PRIN PROGRAMUL OPERATIONAL INFRASTRUCTURA MARE / PROJECT CO-FINANCED FROM THE COHESION FUND, THROUGH THE LARGE INFRASTRUCTURE OPERATIONAL PROGRAM

FAZA PROIECTARE / DESIGN STAGE:
PROIECT TEHNIC DE EXECUTIE / EXECUTION TECHNICAL PROJECT
Contract / Contract: 14724/01.07.2021
Data / Date: 11.2023
Scara / Scale: 1:200

PROIECTAT / DESIGNER:
ing. D. COVELTIR

SEMNTURA / SIGNATURE:
[Signature]

Cod plansa / Drawing code:
CST-0121-PTE-0-DX- 02-P67-PTR-04-R00

VERIFICAT / INTERNAL CHECKER:
ing. D. COVELTIR

| TRASARE RADIER PILA "P8"- fir stanga | | | |
|--------------------------------------|-----------|-----------|-------|
| Pct. | Y-(EST) | X-(NORD) | Z |
| S67-PS8-R01 | 237856.44 | 592646.21 | 88.10 |
| S67-PS8-R02 | 237852.43 | 592649.52 | 88.10 |
| S67-PS8-R03 | 237859.83 | 592658.46 | 88.10 |
| S67-PS8-R04 | 237863.83 | 592655.15 | 88.10 |

| TRASARE PILOTI PILA "P8"- fir stanga | | | | |
|--------------------------------------|-----------|-----------|-------|-------|
| Pct. | Y-(EST) | X-(NORD) | Zsup | Zinf |
| S67-PS8-P01 | 237856.28 | 592647.74 | 88.20 | 66.10 |
| S67-PS8-P02 | 237853.97 | 592649.65 | 88.20 | 66.10 |
| S67-PS8-P03 | 237858.29 | 592650.17 | 88.20 | 66.10 |
| S67-PS8-P04 | 237855.97 | 592652.08 | 88.20 | 66.10 |
| S67-PS8-P05 | 237860.29 | 592652.59 | 88.20 | 66.10 |
| S67-PS8-P06 | 237857.98 | 592654.50 | 88.20 | 66.10 |
| S67-PS8-P07 | 237862.30 | 592655.02 | 88.20 | 66.10 |
| S67-PS8-P08 | 237859.99 | 592656.93 | 88.20 | 66.10 |

PS8

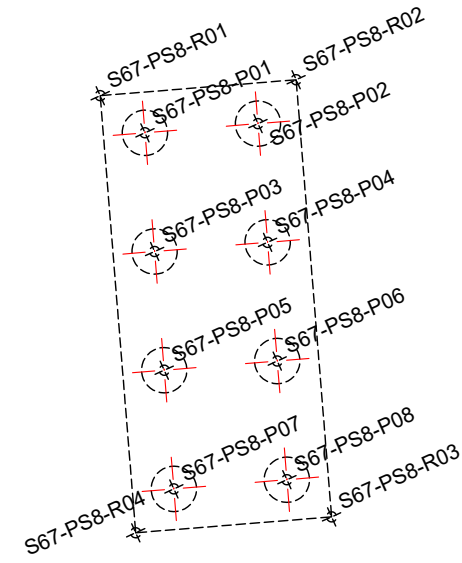

| TRASARE RADIER PILA "P9"- fir stanga | | | |
|--------------------------------------|-----------|-----------|-------|
| Pct. | Y-(EST) | X-(NORD) | Z |
| S67-PS9-R01 | 237829.85 | 592667.97 | 88.25 |
| S67-PS9-R02 | 237828.15 | 592669.36 | 88.25 |
| S67-PS9-R03 | 237835.48 | 592678.41 | 88.25 |
| S67-PS9-R04 | 237837.19 | 592677.02 | 88.25 |

| TRASARE PILOTI PILA "P9"- fir stanga | | | | |
|--------------------------------------|-----------|-----------|-------|-------|
| Pct. | Y-(EST) | X-(NORD) | Zsup | Zinf |
| S67-PS9-P01 | 237829.69 | 592669.52 | 88.35 | 66.25 |
| S67-PS9-P02 | 237831.68 | 592671.97 | 88.35 | 66.25 |
| S67-PS9-P03 | 237833.66 | 592674.41 | 88.35 | 66.25 |
| S67-PS9-P04 | 237835.65 | 592676.86 | 88.35 | 66.25 |

PS9

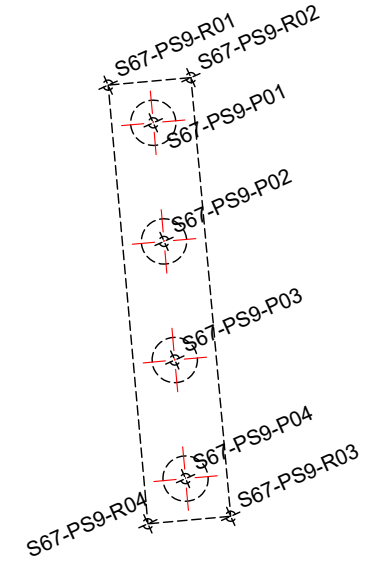

DX



Granița HU/
HU Border



| TRASARE RADIER PILA "P8"- fir dreapta | | | |
|---------------------------------------|-----------|-----------|-------|
| Pct. | Y-(EST) | X-(NORD) | Z |
| S67-PD8-R01 | 237872.16 | 592652.66 | 88.12 |
| S67-PD8-R02 | 237868.16 | 592655.98 | 88.12 |
| S67-PD8-R03 | 237875.57 | 592664.90 | 88.12 |
| S67-PD8-R04 | 237879.57 | 592661.58 | 88.12 |

| TRASARE PILOTI PILA "P8"- fir dreapta | | | | |
|---------------------------------------|-----------|-----------|-------|-------|
| Pct. | Y-(EST) | X-(NORD) | Zsup | Zinf |
| S67-PD8-P01 | 237872.00 | 592654.19 | 88.22 | 66.12 |
| S67-PD8-P02 | 237869.69 | 592656.10 | 88.22 | 66.12 |
| S67-PD8-P03 | 237874.01 | 592656.61 | 88.22 | 66.12 |
| S67-PD8-P04 | 237871.70 | 592658.53 | 88.22 | 66.12 |
| S67-PD8-P05 | 237876.02 | 592659.03 | 88.22 | 66.12 |
| S67-PD8-P06 | 237873.72 | 592660.95 | 88.22 | 66.12 |
| S67-PD8-P07 | 237878.04 | 592661.46 | 88.22 | 66.12 |
| S67-PD8-P08 | 237875.73 | 592663.37 | 88.22 | 66.12 |

PD8

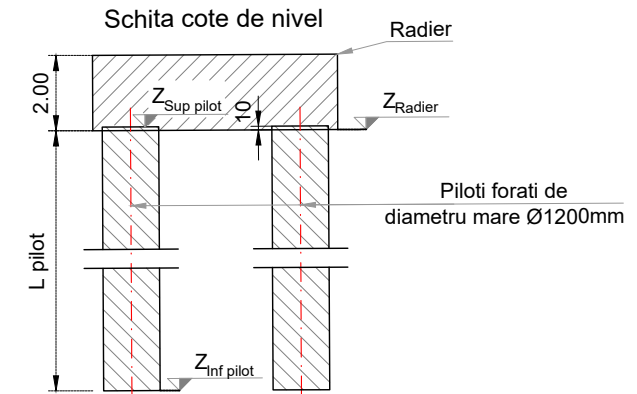
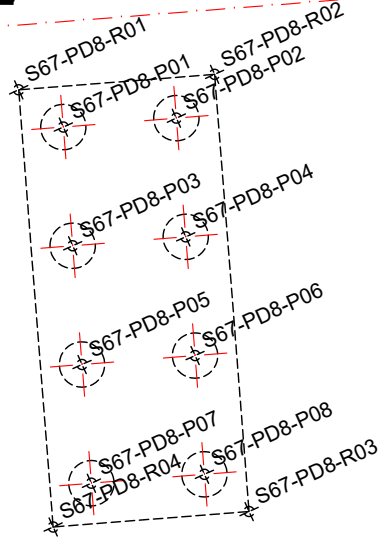

PD09

| TRASARE RADIER PILA "P9"- fir dreapta | | | |
|---------------------------------------|-----------|-----------|-------|
| Pct. | Y-(EST) | X-(NORD) | Z |
| S67-PD9-R01 | 237845.51 | 592674.57 | 88.27 |
| S67-PD9-R02 | 237843.82 | 592675.99 | 88.27 |
| S67-PD9-R03 | 237851.16 | 592684.99 | 88.27 |
| S67-PD9-R04 | 237852.87 | 592683.60 | 88.27 |

| TRASARE PILOTI PILA "P9"- fir dreapta | | | | |
|---------------------------------------|-----------|-----------|-------|-------|
| Pct. | Y-(EST) | X-(NORD) | Zsup | Zinf |
| S67-PD9-P01 | 237845.35 | 592676.12 | 88.37 | 66.27 |
| S67-PD9-P02 | 237847.34 | 592678.56 | 88.37 | 66.27 |
| S67-PD9-P03 | 237849.33 | 592681.01 | 88.37 | 66.27 |
| S67-PD9-P04 | 237851.32 | 592683.45 | 88.37 | 66.27 |

| | | | | | | | | | |
|--|---|--|--|--|--|--|--|--|---|
| PROIECTANT / DESIGNER: S.C. CONSITRANS S.R.L. | BENEFICIAR / BENEFICIARY: MUNICIPIUL ARAD, MUNICIPIUL ORADEA, CONSILIUL JUDETEAN ARAD, CONSILIUL JUDETEAN BIHOR CNAIR | FUNCTIA / POSITION: COORDONATOR DE PROIECT / PROJECT MANAGER | NUME / NAME: ing. S. VEACESLAV | SEMNTATURA / SIGNATURE: | Titlu plansa / Drawing title: Plan trasare - plan 5 / 8 Layout plan - drawing 5 / 8 | REV. / REV.: R00 | DATA / DATE: 11.2023 | DETALII REVIZIE / REVISION DETAILS: P.T.E. | PROIECTAT / DESIGNER: Consitrans |
| | | | | | | INVESTITIA / INVESTMENT: ACTUALIZARE/COMPLETARE/REVIZUIRE (S.F. + P.A.C. + P.O.E + P.T.E.) "DRUM EXPRES ARAD ORADEA" ACTUALIZATION/COMPLETION (S.F. + P.A.C. + P.O.E + P.T.E.) "EXPRESS ROAD ARAD ORADEA" | SEF PROIECT SPECIALITATE / TEAM LEADER: ing. D. COVELTIR | PROIECTAT / DESIGNER: ing. V. URDAREANU | Cod plansa / Drawing code: CST-0121-PTE-0-DX- 02-P67-PTR-05-R00 |
| FAZA PROIECTARE / DESIGN STAGE: PROIECT TEHNIC DE EXECUTIE / EXECUTION TECHNICAL PROJECT | Contract /Contract: 14724/01.07.2021 Project /Project no.: 001/2021 | Data / Date: 11.2023 | Scara /Scale: 1:200 | VERIFICAT / INTERNAL CHECKER: ing. D. COVELTIR | | | | | |



PROIECT CO-FINANȚAT DIN FONDUL DE COEZIUNE, PRIN PROGRAMUL OPERAȚIONAL INFRASTRUCTURĂ MARE / PROJECT CO-FINANCED FROM THE COHESION FUND, THROUGH THE LARGE INFRASTRUCTURE OPERATIONAL PROGRAM

| TRASARE RADIER PILA "P10"- fir stanga | | | |
|---------------------------------------|-----------|-----------|-------|
| Pct. | Y-(EST) | X-(NORD) | Z |
| S67-PS10-R01 | 237797.62 | 592693.83 | 88.09 |
| S67-PS10-R02 | 237795.89 | 592695.19 | 88.09 |
| S67-PS10-R03 | 237803.12 | 592704.33 | 88.09 |
| S67-PS10-R04 | 237804.85 | 592702.96 | 88.09 |

| TRASARE PILOTI PILA "P10"- fir stanga | | | | |
|---------------------------------------|-----------|-----------|-------|-------|
| Pct. | Y-(EST) | X-(NORD) | Zsup | Zinf |
| S67-PS10-P01 | 237797.44 | 592695.37 | 88.19 | 66.09 |
| S67-PS10-P02 | 237799.39 | 592697.84 | 88.19 | 66.09 |
| S67-PS10-P03 | 237801.35 | 592700.31 | 88.19 | 66.09 |
| S67-PS10-P04 | 237803.30 | 592702.78 | 88.19 | 66.09 |

PS10

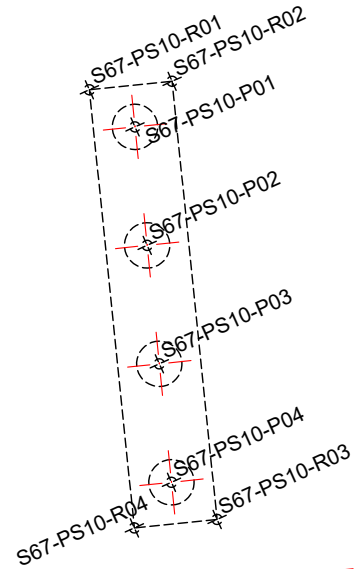

| TRASARE RADIER PILA "P11"- fir stanga | | | |
|---------------------------------------|-----------|-----------|-------|
| Pct. | Y-(EST) | X-(NORD) | Z |
| S67-PS11-R01 | 237772.96 | 592713.21 | 88.19 |
| S67-PS11-R02 | 237768.86 | 592716.40 | 88.19 |
| S67-PS11-R03 | 237775.97 | 592725.56 | 88.19 |
| S67-PS11-R04 | 237780.08 | 592722.37 | 88.19 |

| TRASARE PILOTI PILA "P11"- fir stanga | | | | |
|---------------------------------------|-----------|-----------|-------|-------|
| Pct. | Y-(EST) | X-(NORD) | Zsup | Zinf |
| S67-PS11-P01 | 237772.75 | 592714.73 | 88.29 | 66.19 |
| S67-PS11-P02 | 237770.38 | 592716.57 | 88.29 | 66.19 |
| S67-PS11-P03 | 237774.69 | 592717.22 | 88.29 | 66.19 |
| S67-PS11-P04 | 237772.32 | 592719.06 | 88.29 | 66.19 |
| S67-PS11-P05 | 237776.62 | 592719.71 | 88.29 | 66.19 |
| S67-PS11-P06 | 237774.25 | 592721.55 | 88.29 | 66.19 |
| S67-PS11-P07 | 237778.55 | 592722.20 | 88.29 | 66.19 |
| S67-PS11-P08 | 237776.18 | 592724.04 | 88.29 | 66.19 |

PS11

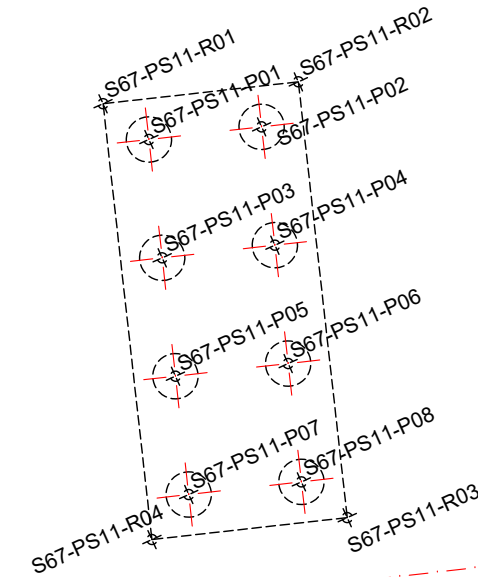

Granița HU/
HU Border

DX

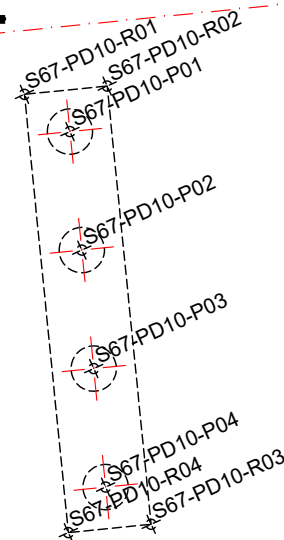

PD10

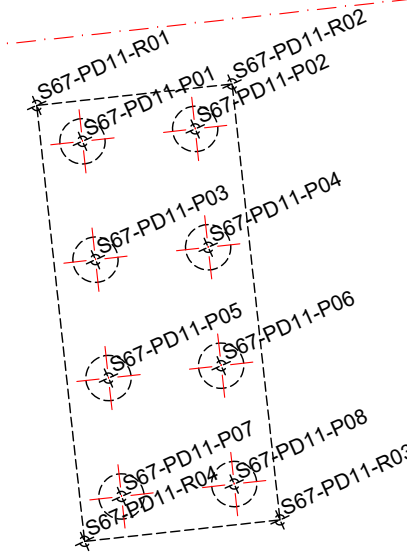

PD11

| TRASARE RADIER PILA "P11"- fir dreapta | | | |
|--|-----------|-----------|-------|
| Pct. | Y-(EST) | X-(NORD) | Z |
| S67-PD11-R01 | 237788.47 | 592720.14 | 88.24 |
| S67-PD11-R02 | 237784.37 | 592723.34 | 88.24 |
| S67-PD11-R03 | 237791.51 | 592732.48 | 88.24 |
| S67-PD11-R04 | 237795.61 | 592729.29 | 88.24 |

| TRASARE PILOTI PILA "P11"- fir dreapta | | | | |
|--|-----------|-----------|-------|-------|
| Pct. | Y-(EST) | X-(NORD) | Zsup | Zinf |
| S67-PD11-P01 | 237788.27 | 592721.66 | 88.34 | 66.24 |
| S67-PD11-P02 | 237785.90 | 592723.51 | 88.34 | 66.24 |
| S67-PD11-P03 | 237790.20 | 592724.15 | 88.34 | 66.24 |
| S67-PD11-P04 | 237787.84 | 592725.99 | 88.34 | 66.24 |
| S67-PD11-P05 | 237792.14 | 592726.63 | 88.34 | 66.24 |
| S67-PD11-P06 | 237789.78 | 592728.48 | 88.34 | 66.24 |
| S67-PD11-P07 | 237794.08 | 592729.11 | 88.34 | 66.24 |
| S67-PD11-P08 | 237791.71 | 592730.96 | 88.34 | 66.24 |

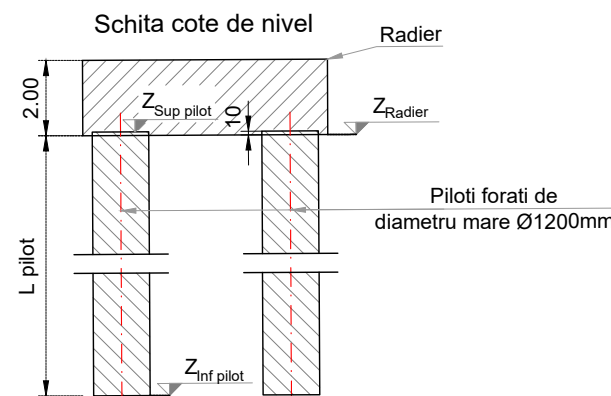

| TRASARE RADIER PILA "P10"- fir dreapta | | | |
|--|-----------|-----------|-------|
| Pct. | Y-(EST) | X-(NORD) | Z |
| S67-PD10-R01 | 237813.19 | 592700.61 | 88.13 |
| S67-PD10-R02 | 237811.47 | 592701.98 | 88.13 |
| S67-PD10-R03 | 237818.72 | 592711.10 | 88.13 |
| S67-PD10-R04 | 237820.44 | 592709.73 | 88.13 |

| TRASARE PILOTI PILA "P10"- fir dreapta | | | | |
|--|-----------|-----------|-------|-------|
| Pct. | Y-(EST) | X-(NORD) | Zsup | Zinf |
| S67-PD10-P01 | 237813.02 | 592702.16 | 88.23 | 66.13 |
| S67-PD10-P02 | 237814.98 | 592704.62 | 88.23 | 66.13 |
| S67-PD10-P03 | 237816.94 | 592707.09 | 88.23 | 66.13 |
| S67-PD10-P04 | 237818.90 | 592709.55 | 88.23 | 66.13 |

PROIECTANT / DESIGNER:
S.C. CONSITRANS S.R.L.



BENEFICIAR / BENEFICIARY:
MUNICIPIUL ARAD, MUNICIPIUL ORADEA, CONSILIUL JUDETEAN ARAD, CONSILIUL JUDETEAN BIHOR CNAIR

FUNCTIA / POSITION:
COORDONATOR DE PROIECT / PROJECT MANAGER

NUME / NAME:
ing. S. VEACESLAV

SEMNATURA / SIGNATURE:
[Signature]

Titlu plansa / Drawing title:
Plan trasare - plan 6 / 8
Layout plan - drawing 6 / 8

REV / REV.:
R00

DATA / DATE:
11.2023

DETALII REVIZIE / REVISION DETAILS:
P.T.E.

PROIECTAT / DESIGNER:
Consitrans

INVESTITIA / INVESTMENT:
ACTUALIZARE/COMPLETARE/REVIZUIRE (S.F. + P.A.C. + P.O.E + P.T.E.) "DRUM EXPRES ARAD ORADEA"
ACTUALIZATION/COMPLETION (S.F. + P.A.C. + P.O.E + P.T.E.) "EXPRESS ROAD ARAD ORADEA"

SEF PROIECT SPECIALITATE / TEAM LEADER

ing. D. COVELTIR

[Signature]

Pasaj pe DL HU la km 4+870 peste CF si DN79B
Bridge on DL HU at km 4+870 over CF and DN79B

FAZA PROIECTARE / DESIGN STAGE:
PROIECT TEHNIC DE EXECUTIE / EXECUTION TECHNICAL PROJECT

PROIECTAT / DESIGNER:

ing. V. URDAREANU

[Signature]

LUCRARI DE POD / BRIDGE WORKS

Contract / Contract: 14724/01.07.2021
Data / Date: 11.2023
Scara / Scale: 1:200

VERIFICAT / INTERNAL CHECKER:

ing. D. COVELTIR

[Signature]

Cod plansa / Drawing code:
CST-0121-PTE-0-DX- 02-P67-PTR-06-R00



UNIUNEA EUROPEANA



GUVERNUL ROMANIEI



Instrumente Structurale 2014-2020

PROIECT CO-FINANȚAT DIN FONDUL DE COEZIUNE, PRIN PROGRAMUL OPERAȚIONAL INFRASTRUCTURĂ MARE / PROJECT CO-FINANCED FROM THE COHESION FUND, THROUGH THE LARGE INFRASTRUCTURE OPERATIONAL PROGRAM

| TRASARE RADIER PILA "P12"- fir stanga | | | |
|---------------------------------------|-----------|-----------|-------|
| Pct. | Y-(EST) | X-(NORD) | Z |
| S67-PS12-R01 | 237745.72 | 592734.15 | 88.19 |
| S67-PS12-R02 | 237743.97 | 592735.48 | 88.19 |
| S67-PS12-R03 | 237751.03 | 592744.75 | 88.19 |
| S67-PS12-R04 | 237752.78 | 592743.42 | 88.19 |

| TRASARE PILOTI PILA "P12"- fir stanga | | | | |
|---------------------------------------|-----------|-----------|-------|-------|
| Pct. | Y-(EST) | X-(NORD) | Zsup | Zinf |
| S67-PS12-P01 | 237745.51 | 592735.69 | 88.29 | 66.19 |
| S67-PS12-P02 | 237747.42 | 592738.20 | 88.29 | 66.19 |
| S67-PS12-P03 | 237749.33 | 592740.70 | 88.29 | 66.19 |
| S67-PS12-P04 | 237751.24 | 592743.21 | 88.29 | 66.19 |

| TRASARE RADIER PILA "P13"- fir stanga | | | |
|---------------------------------------|-----------|-----------|-------|
| Pct. | Y-(EST) | X-(NORD) | Z |
| S67-PS13-R01 | 237712.70 | 592759.00 | 88.31 |
| S67-PS13-R02 | 237710.94 | 592760.31 | 88.31 |
| S67-PS13-R03 | 237717.88 | 592769.66 | 88.31 |
| S67-PS13-R04 | 237719.65 | 592768.35 | 88.31 |

| TRASARE PILOTI PILA "P13"- fir stanga | | | | |
|---------------------------------------|-----------|-----------|-------|-------|
| Pct. | Y-(EST) | X-(NORD) | Zsup | Zinf |
| S67-PS13-P01 | 237712.48 | 592760.54 | 88.41 | 66.31 |
| S67-PS13-P02 | 237714.35 | 592763.07 | 88.41 | 66.31 |
| S67-PS13-P03 | 237716.23 | 592765.60 | 88.41 | 66.31 |
| S67-PS13-P04 | 237718.11 | 592768.12 | 88.41 | 66.31 |

| TRASARE RADIER PILA "P13"- fir dreapta | | | |
|--|-----------|-----------|-------|
| Pct. | Y-(EST) | X-(NORD) | Z |
| S67-PD13-R01 | 237721.65 | 592771.04 | 88.31 |
| S67-PD13-R02 | 237719.88 | 592772.35 | 88.31 |
| S67-PD13-R03 | 237726.83 | 592781.70 | 88.31 |
| S67-PD13-R04 | 237728.60 | 592780.39 | 88.31 |

| TRASARE PILOTI PILA "P13"- fir dreapta | | | | |
|--|-----------|-----------|-------|-------|
| Pct. | Y-(EST) | X-(NORD) | Zsup | Zinf |
| S67-PD13-P01 | 237721.42 | 592772.58 | 88.41 | 66.31 |
| S67-PD13-P02 | 237723.30 | 592775.11 | 88.41 | 66.31 |
| S67-PD13-P03 | 237725.18 | 592777.64 | 88.41 | 66.31 |
| S67-PD13-P04 | 237727.06 | 592780.17 | 88.41 | 66.31 |



PS12

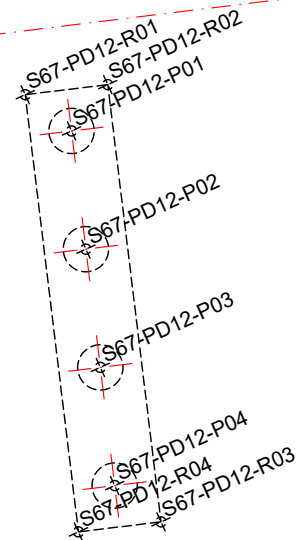
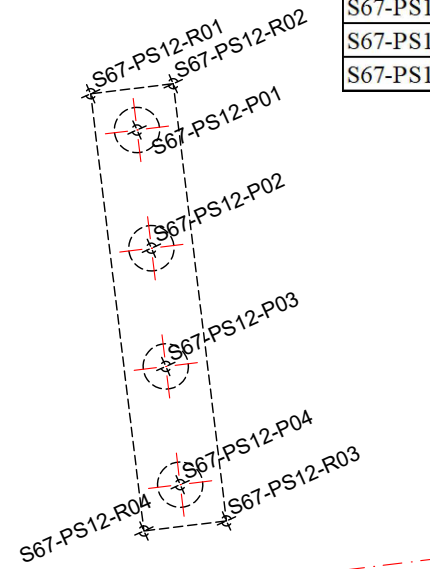

PD12

| TRASARE RADIER PILA "P12"- fir dreapta | | | |
|--|-----------|-----------|-------|
| Pct. | Y-(EST) | X-(NORD) | Z |
| S67-PD12-R01 | 237754.81 | 592746.08 | 88.17 |
| S67-PD12-R02 | 237753.06 | 592747.42 | 88.17 |
| S67-PD12-R03 | 237760.12 | 592756.68 | 88.17 |
| S67-PD12-R04 | 237761.87 | 592755.35 | 88.17 |

| TRASARE PILOTI PILA "P12"- fir dreapta | | | | |
|--|-----------|-----------|-------|-------|
| Pct. | Y-(EST) | X-(NORD) | Zsup | Zinf |
| S67-PD12-P01 | 237754.60 | 592747.62 | 88.27 | 66.17 |
| S67-PD12-P02 | 237756.51 | 592750.13 | 88.27 | 66.17 |
| S67-PD12-P03 | 237758.42 | 592752.64 | 88.27 | 66.17 |
| S67-PD12-P04 | 237760.32 | 592755.14 | 88.27 | 66.17 |

PS13

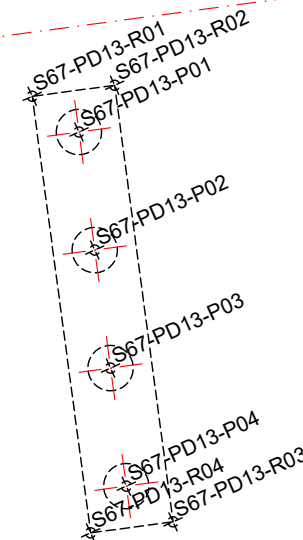
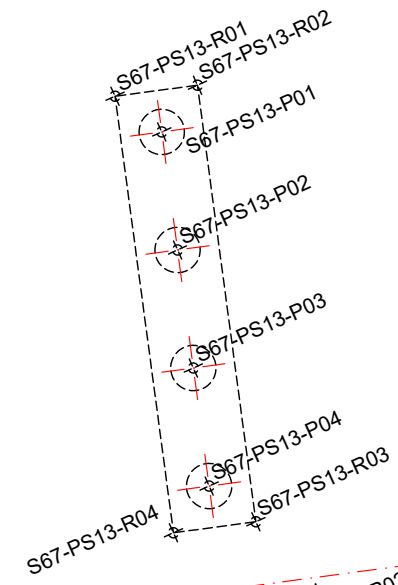

PD13

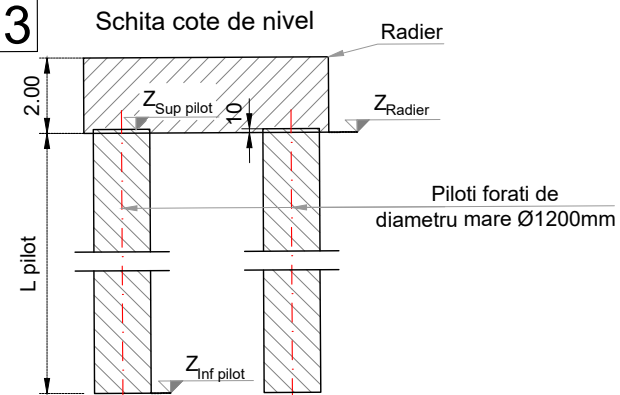

Granița HU/
HU Border



DX ←

| | | | | | | | | | |
|--|---|--|--|--|--|--|--|--|---|
| PROIECTANT / DESIGNER: S.C. CONSITRANS S.R.L. | BENEFICIAR / BENEFICIARY: MUNICIPIUL ARAD, MUNICIPIUL ORADEA, CONSILIUL JUDETEAN ARAD, CONSILIUL JUDETEAN BIHOR CNAIR | FUNCTIA / POSITION: COORDONATOR DE PROIECT / PROJECT MANAGER | NUME / NAME: ing. S. VEACESLAV | SEMNATURA / SIGNATURE: | Titlu plansa / Drawing title: Plan trasare - plan 7 / 8 Layout plan - drawing 7 / 8 | REV. / REV.: R00 | DATA / DATE: 11.2023 | DETALII REVIZIE / REVISION DETAILS: P.T.E. | PROIECTAT / DESIGNER: Consitrans |
| | | | | | | INVESTITIA / INVESTMENT: ACTUALIZARE/COMPLETARE/REVIZUIRE (S.F. + P.A.C. + P.O.E + P.T.E.) "DRUM EXPRES ARAD ORADEA" ACTUALIZATION/COMPLETION (S.F. + P.A.C. + P.O.E + P.T.E.) "EXPRESS ROAD ARAD ORADEA" | SEF PROIECT SPECIALITATE / TEAM LEADER: ing. D. COVELTIR | PROIECTAT / DESIGNER: ing. V. URDAREANU | Cod plansa / Drawing code: CST-0121-PTE-0-DX- 02-P67-PTR-07-R00 |
| FAZA PROIECTARE / DESIGN STAGE: PROIECT TEHNIC DE EXECUTIE / EXECUTION TECHNICAL PROJECT | Contract /Contract: 14724/01.07.2021 Project /Project no.: 001/2021 | Data / Date: 11.2023 | Scara /Scale: 1:200 | VERIFICAT / INTERNAL CHECKER: ing. D. COVELTIR | VERIFICAT / INTERNAL CHECKER: | | | | |

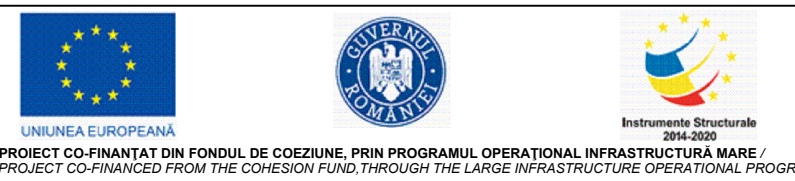

| TRASARE RADIER PILA "P14"- fir stanga | | | |
|---------------------------------------|-----------|-----------|-------|
| Pct. | Y-(EST) | X-(NORD) | Z |
| S67-PS14-R01 | 237679.39 | 592783.46 | 87.87 |
| S67-PS14-R02 | 237677.61 | 592784.75 | 87.87 |
| S67-PS14-R03 | 237684.45 | 592794.18 | 87.87 |
| S67-PS14-R04 | 237686.23 | 592792.89 | 87.87 |

| TRASARE PILOTI PILA "P14"- fir stanga | | | | |
|---------------------------------------|-----------|-----------|-------|-------|
| Pct. | Y-(EST) | X-(NORD) | Zsup | Zinf |
| S67-PS14-P01 | 237679.15 | 592784.99 | 87.97 | 65.87 |
| S67-PS14-P02 | 237681.00 | 592787.54 | 87.97 | 65.87 |
| S67-PS14-P03 | 237682.85 | 592790.09 | 87.97 | 65.87 |
| S67-PS14-P04 | 237684.69 | 592792.65 | 87.97 | 65.87 |

PS14

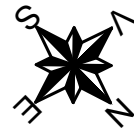
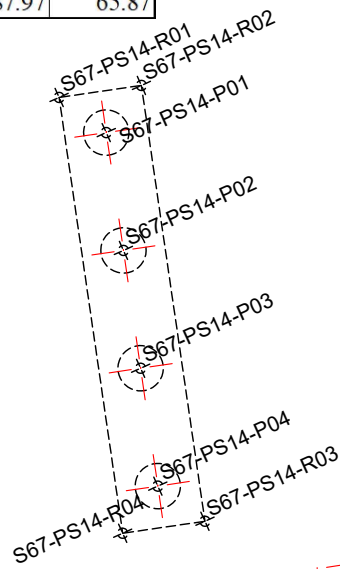

| TRASARE RADIER CULEE "C2"-fir stg | | | |
|-----------------------------------|-----------|-----------|-------|
| Pct. | X-(EST) | Y-(NORD) | Z |
| S67-CS2-R01 | 237650.20 | 592804.40 | 88.01 |
| S67-CS2-R02 | 237643.26 | 592809.31 | 88.01 |
| S67-CS2-R03 | 237649.99 | 592818.82 | 88.01 |
| S67-CS2-R04 | 237656.93 | 592813.91 | 88.01 |

| TRASARE PILOTI CULEE "C2"-fir stg | | | | |
|-----------------------------------|-----------|-----------|-------|-------|
| Pct. | X-(EST) | Y-(NORD) | Zsup | Zinf |
| S67-CS2-P01 | 237649.94 | 592805.94 | 88.11 | 66.01 |
| S67-CS2-P02 | 237647.37 | 592807.75 | 88.11 | 66.01 |
| S67-CS2-P03 | 237644.79 | 592809.57 | 88.11 | 66.01 |
| S67-CS2-P04 | 237651.76 | 592808.51 | 88.11 | 66.01 |
| S67-CS2-P05 | 237649.19 | 592810.33 | 88.11 | 66.01 |
| S67-CS2-P06 | 237646.61 | 592812.15 | 88.11 | 66.01 |
| S67-CS2-P07 | 237653.58 | 592811.08 | 88.11 | 66.01 |
| S67-CS2-P08 | 237651.00 | 592812.90 | 88.11 | 66.01 |
| S67-CS2-P09 | 237648.43 | 592814.72 | 88.11 | 66.01 |
| S67-CS2-P10 | 237655.40 | 592813.65 | 88.11 | 66.01 |
| S67-CS2-P11 | 237652.82 | 592815.47 | 88.11 | 66.01 |
| S67-CS2-P12 | 237650.25 | 592817.29 | 88.11 | 66.01 |

CS2

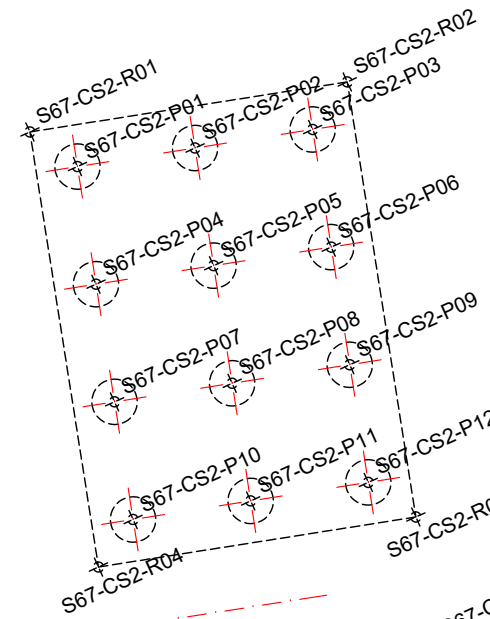

Granița HU/
HU Border



DX

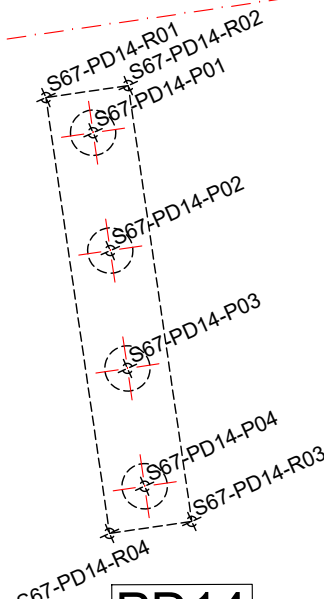

PD14

| TRASARE RADIER PILA "P14"- fir dreapta | | | |
|--|-----------|-----------|-------|
| Pct. | Y-(EST) | X-(NORD) | Z |
| S67-PD14-R01 | 237688.20 | 592795.60 | 87.87 |
| S67-PD14-R02 | 237686.41 | 592796.89 | 87.87 |
| S67-PD14-R03 | 237693.25 | 592806.33 | 87.87 |
| S67-PD14-R04 | 237695.03 | 592805.04 | 87.87 |

| TRASARE PILOTI PILA "P14"- fir dreapta | | | | |
|--|-----------|-----------|-------|-------|
| Pct. | Y-(EST) | X-(NORD) | Zsup | Zinf |
| S67-PD14-P01 | 237687.95 | 592797.14 | 87.97 | 65.87 |
| S67-PD14-P02 | 237689.80 | 592799.69 | 87.97 | 65.87 |
| S67-PD14-P03 | 237691.65 | 592802.24 | 87.97 | 65.87 |
| S67-PD14-P04 | 237693.50 | 592804.79 | 87.97 | 65.87 |

| TRASARE RADIER CULEE "C2"-fir dr | | | |
|----------------------------------|-----------|-----------|-------|
| Pct. | X-(EST) | Y-(NORD) | Z |
| S67-CD2-R01 | 237658.86 | 592816.65 | 88.01 |
| S67-CD2-R02 | 237651.92 | 592821.56 | 88.01 |
| S67-CD2-R03 | 237658.65 | 592831.07 | 88.01 |
| S67-CD2-R04 | 237665.59 | 592826.16 | 88.01 |

| TRASARE PILOTI CULEE "C2"-fir dr | | | | |
|----------------------------------|-----------|-----------|-------|-------|
| Pct. | X-(EST) | Y-(NORD) | Zsup | Zinf |
| S67-CD2-P01 | 237658.60 | 592818.18 | 88.11 | 66.01 |
| S67-CD2-P02 | 237656.03 | 592820.00 | 88.11 | 66.01 |
| S67-CD2-P03 | 237653.46 | 592821.82 | 88.11 | 66.01 |
| S67-CD2-P04 | 237660.42 | 592820.75 | 88.11 | 66.01 |
| S67-CD2-P05 | 237657.85 | 592822.57 | 88.11 | 66.01 |
| S67-CD2-P06 | 237655.28 | 592824.39 | 88.11 | 66.01 |
| S67-CD2-P07 | 237662.24 | 592823.33 | 88.11 | 66.01 |
| S67-CD2-P08 | 237659.67 | 592825.14 | 88.11 | 66.01 |
| S67-CD2-P09 | 237657.09 | 592826.96 | 88.11 | 66.01 |
| S67-CD2-P10 | 237664.06 | 592825.90 | 88.11 | 66.01 |
| S67-CD2-P11 | 237661.49 | 592827.72 | 88.11 | 66.01 |
| S67-CD2-P12 | 237658.91 | 592829.54 | 88.11 | 66.01 |

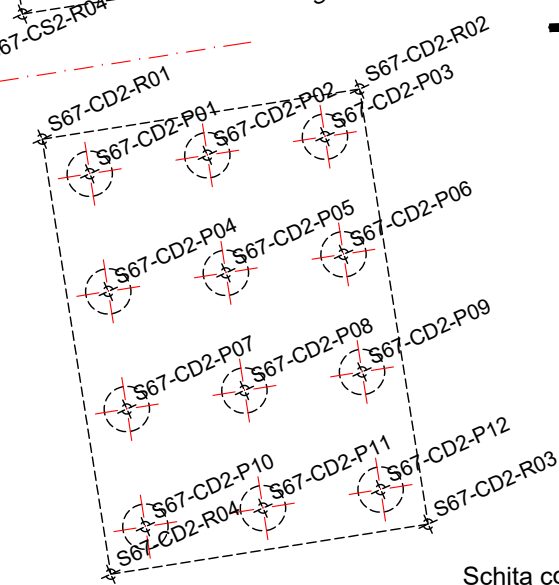

CD2

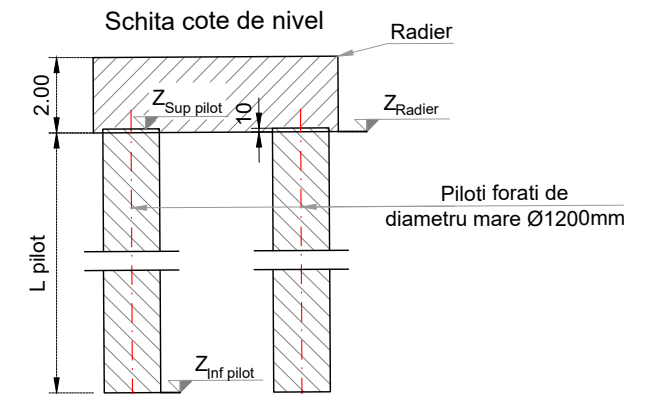

PROIECTANT / DESIGNER:
S.C. CONSITRANS S.R.L.



BENEFICIAR / BENEFICIARY:
MUNICIPIUL ARAD, MUNICIPIUL ORADEA, CONSILIUL JUDETEAN ARAD, CONSILIUL JUDETEAN BIHOR CNAIR

FUNCTIA / POSITION:
COORDONATOR DE PROIECT / PROJECT MANAGER

NUME / NAME:
ing. S. VEACESLAV

SEMNTATURA / SIGNATURE:
[Signature]

Titlu plansa / Drawing title:
Plan trasare - plan 8 / 8
Layout plan - drawing 8 / 8

| REV/REV. | DATA/DATE | DETALII REVIZIE / REVISION DETAILS | PROIECTAT / DESIGNER |
|----------|-----------|------------------------------------|----------------------|
| R00 | 11.2023 | P.T.E. | Consitrans |

INVESTITIA / INVESTMENT:
ACTUALIZARE/COMPLETARE/REVIZUIRE (S.F. + P.A.C. + P.O.E + P.T.E.) "DRUM EXPRES ARAD ORADEA"
ACTUALIZATION/COMPLETION (S.F. + P.A.C. + P.O.E + P.T.E.) "EXPRESS ROAD ARAD ORADEA"

SEF PROIECT SPECIALITATE / TEAM LEADER
ing. D. COVELTIR

SEMNTATURA / SIGNATURE:
[Signature]

Pasaj pe DL HU la km 4+870 peste CF si DN79B
Bridge on DL HU at km 4+870 over CF and DN79B

FAZA PROIECTARE / DESIGN STAGE:
PROIECT TEHNIC DE EXECUTIE / EXECUTION TECHNICAL PROJECT

PROIECTAT / DESIGNER:
ing. V. URDAREANU

SEMNTATURA / SIGNATURE:
[Signature]

LUCRARI DE POD / BRIDGE WORKS

Contract /Contract: 14724/01.07.2021
Data /Date: 11.2023
Scara /Scale: 1:200

VERIFICAT / INTERNAL CHECKER:
ing. D. COVELTIR

SEMNTATURA / SIGNATURE:
[Signature]

Cod plansa / Drawing code:
CST-0121-PTE-0-DX- 02-P67-PTR-08-R00



PROIECT CO-FINANȚAT DIN FONDUL DE COEZIUNE, PRIN PROGRAMUL OPERAȚIONAL INFRASTRUCTURĂ MARE / PROJECT CO-FINANCED FROM THE COHESION FUND, THROUGH THE LARGE INFRASTRUCTURE OPERATIONAL PROGRAM